

Backverriere

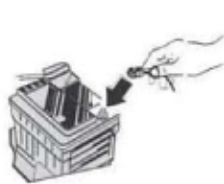

Radio Code

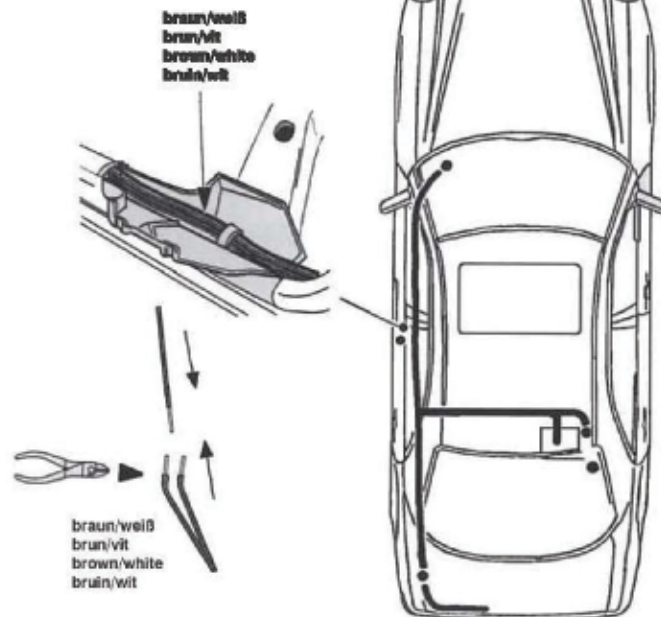

FUNKTIONEN KONTROLLIEREN
FUNKTIONSTEST
CHECK FUNKTIONS
CONTROLEER FUNCTIES

MERCEDES W210/S210 1995- CLK C208 1997-

- D** Einbauanweisung
Elektrischer Zubehörsatz
- GB** Installation Instructions
Electrical Accessories Set
- F** Instructions de montage
Jeu d'accessoires électriques
- I** Istruzioni di montaggio
Kit di montaggio elettrico
- E** Instrucciones de montaje
Juego de accesorios eléctrico
- NL** Inbouwhandleiding
Elektrisch Toebehoorpakket



INFO + ROUTING W210 / S210

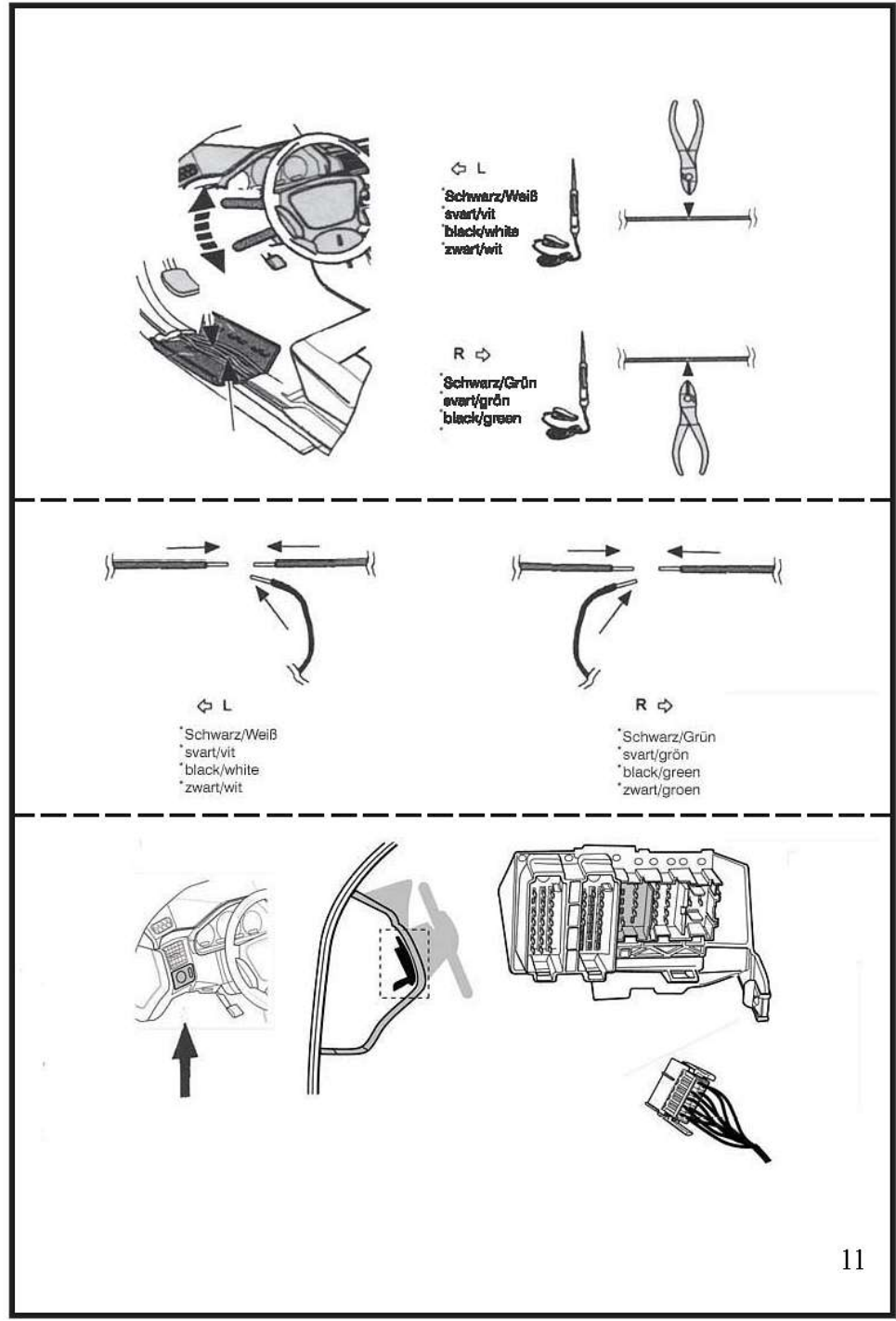
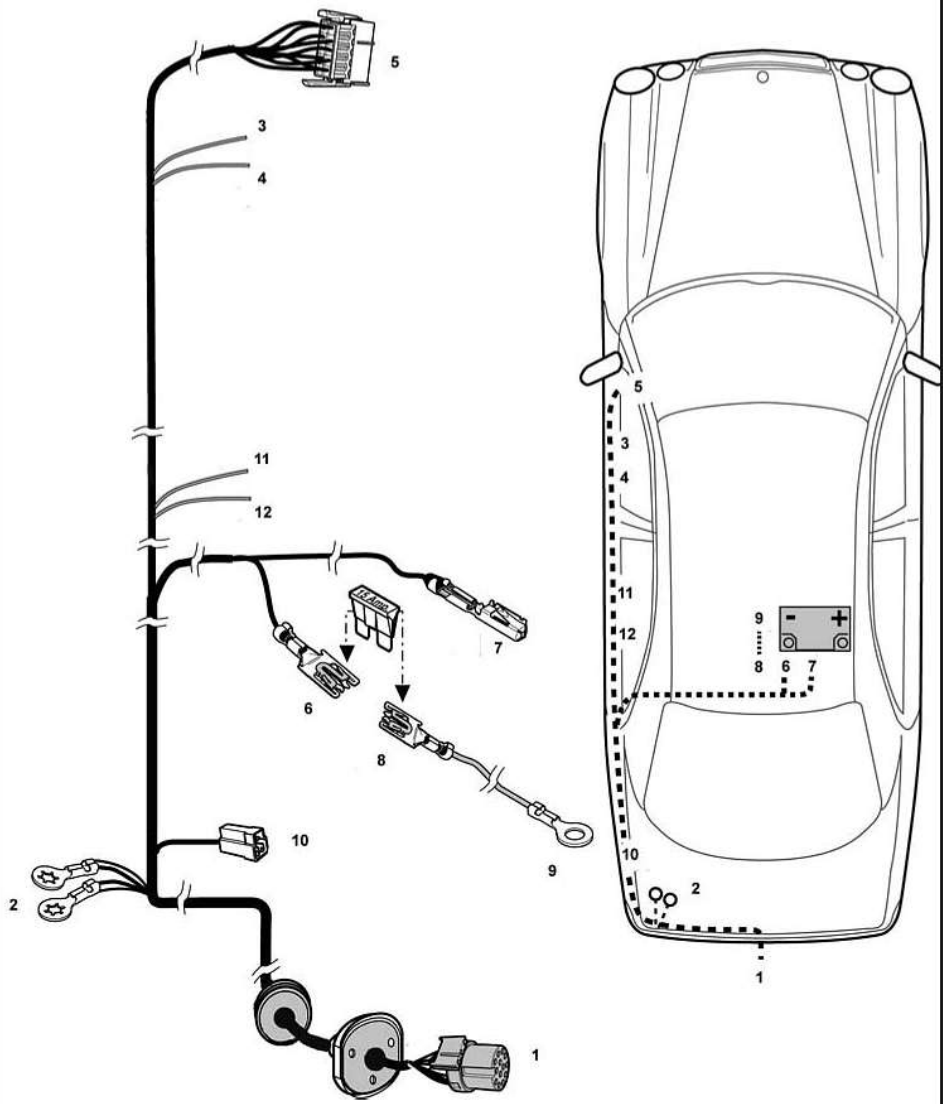

W210 + S210

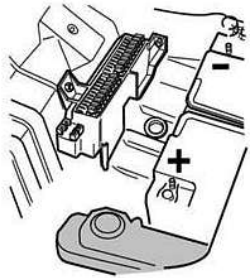

C208

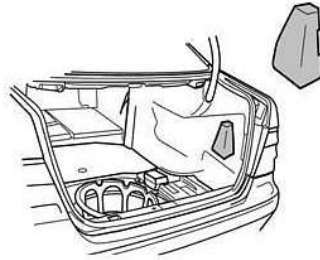

- X kann 4-, 12- oder 18-polig sein
Siehe in der Tabelle für die richtige Position
- X kan vara 4-, 12- eller 18 pol
se tabell för rätt position
- X can be 4-, 12- or 18-pole
See table for the right position
- X kan 4-, 12- of 18-polig zijn
Voor de juiste positie zie tabel

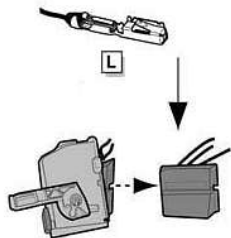
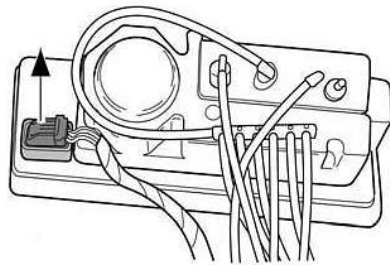

Poles	X	Position
4	→	2
12	→	2
18	→	15

INFO + ROUTING C208

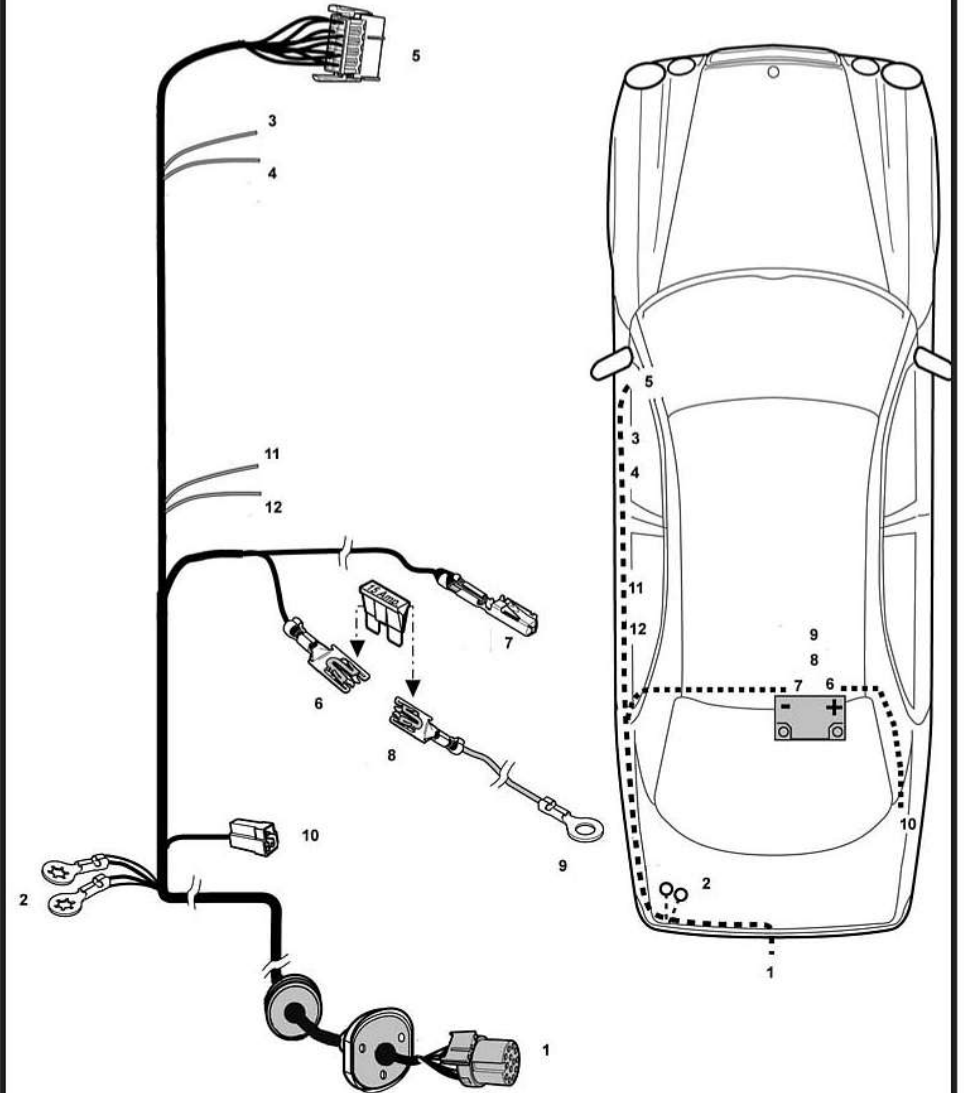

W210

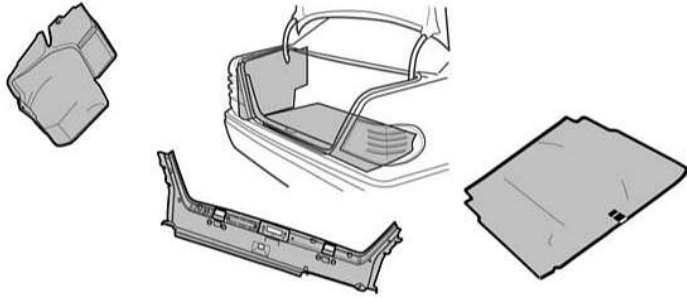

S210

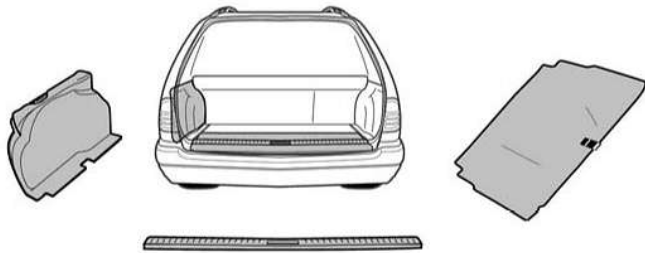

W210+S210

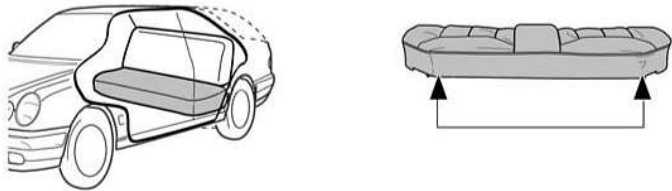

C208

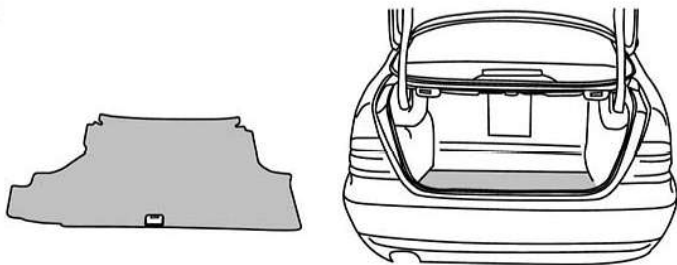

13p

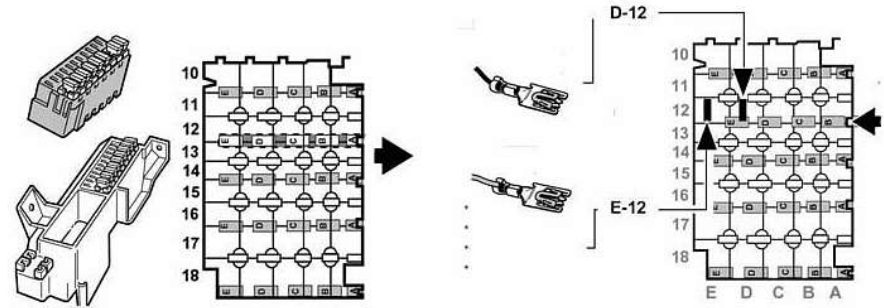

13p

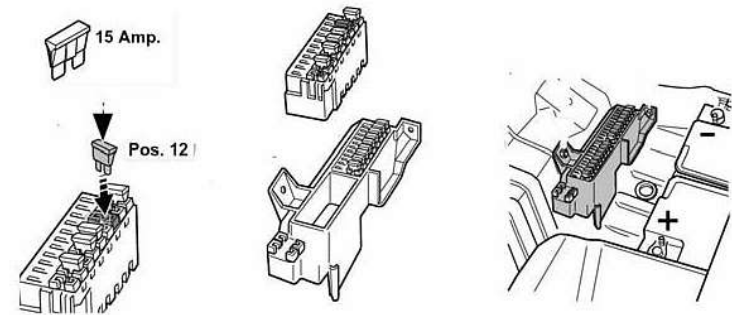

13p

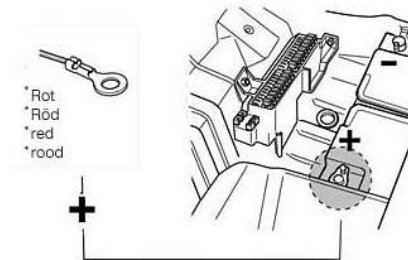

13p

W210+S210

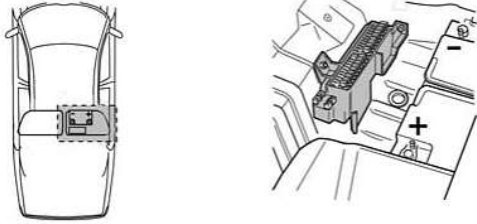

13p

C208

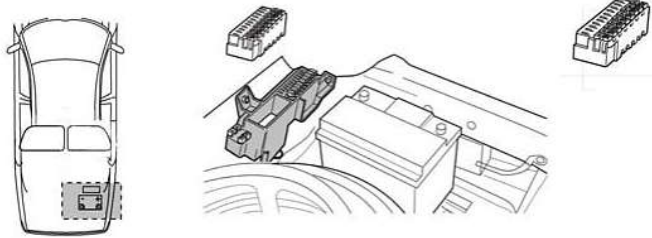

13p

OPTIE 208

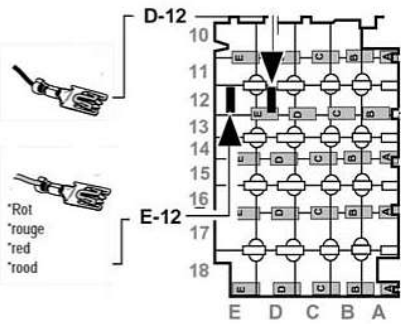
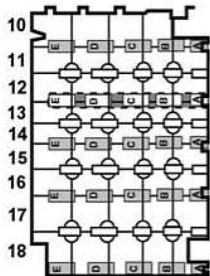
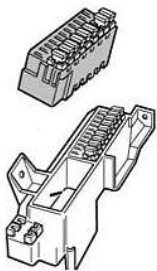
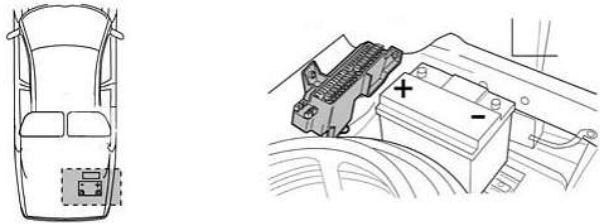

*Rot
*rouge
*red
*rood

C208

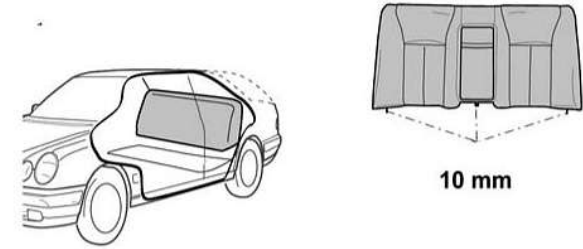
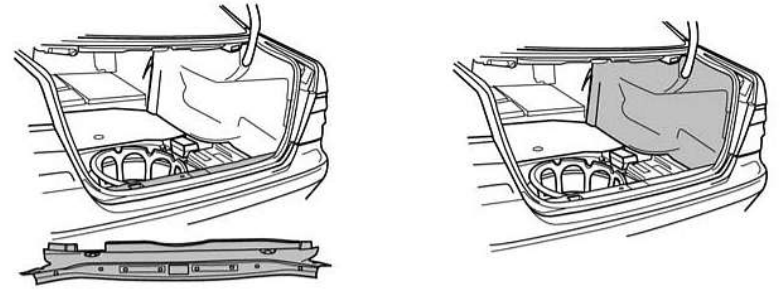

10 mm

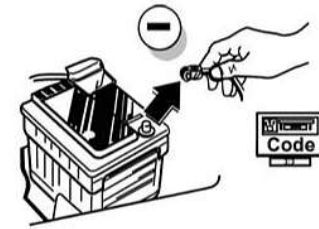

Code

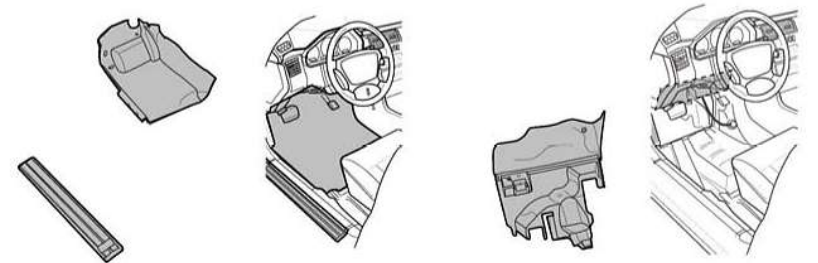

C208

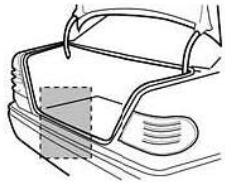
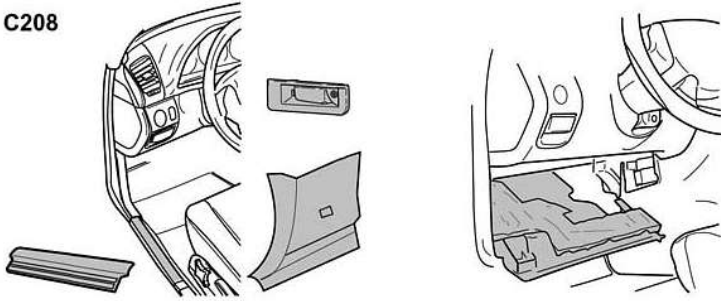

W210

S210

C208

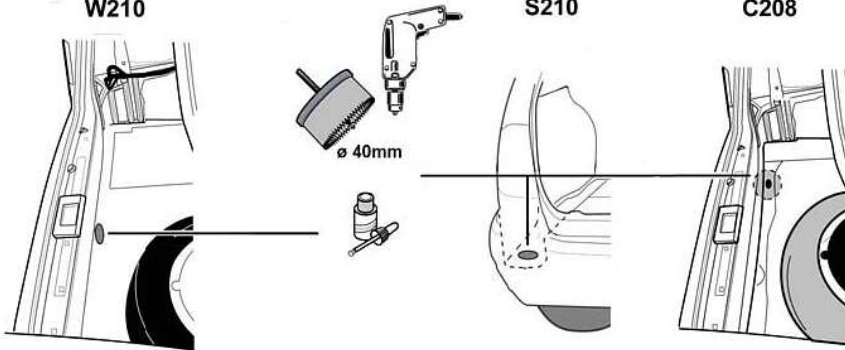

W210+S210

C208

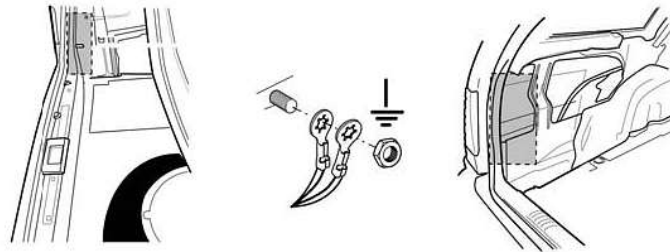

W210+S210

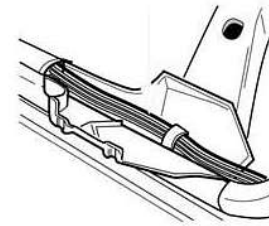
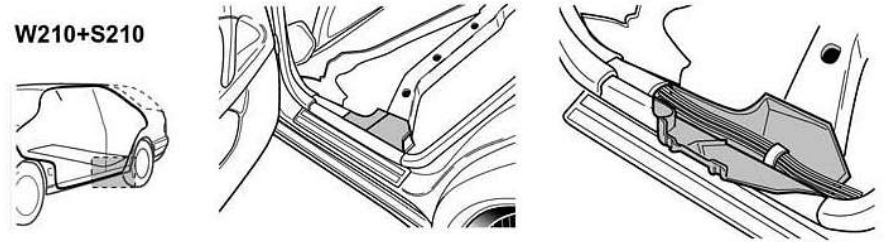

*Grau/Grün
 *grá/grön
 *grey/green
 *grijs/groen



C208

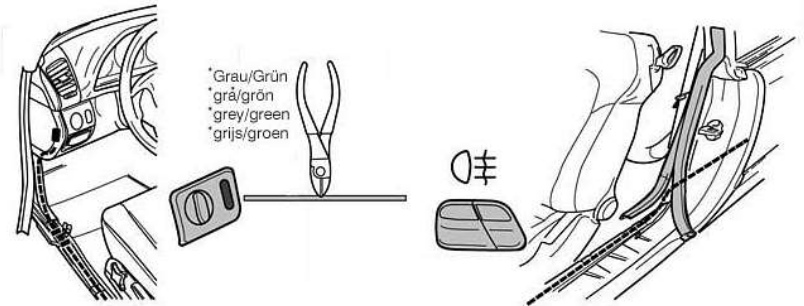

*Grau/Grün
 *grá/grön
 *grey/green
 *grijs/groen



*Grau/Grün
 *grá/grön
 *grey/green
 *grijs/groen



*Grau
 *grá
 *grey
 *grijs

*Grau/Grün
 *grá/grön
 *grey/green
 *grijs/groen