

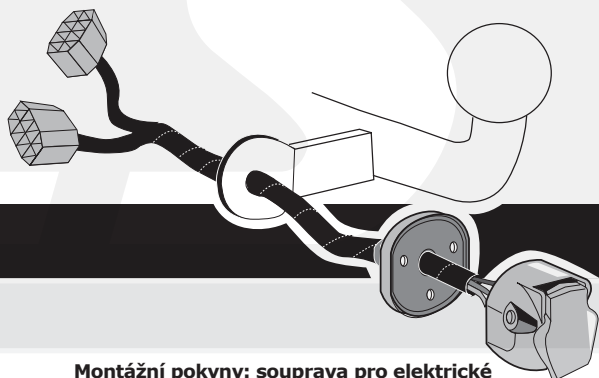

- BMW 1 Series E81, E82, E87, E88
- BMW 1 Series F20, F21 (without PDC cut off function)
- BMW 3 Series E90, E91, E92, E93
- BMW 3 Series F30, F31 (without PDC cut off function)
- BMW 5 Series E60, E61, F07, F10, F11
- BMW 7 Series E65, E66, F01, F02
- BMW X1 Series E84
- BMW X3 Series F25
- BMW X5 Series E70
- BMW X6 Series E71



Partnr.: BW-008-B1

DE	Einbauanleitung Elektrosatz Anhängervorrichtung mit 12-N Steckdose lt. DIN/ISO Norm 1724.	
FR	Instructions de montage du faisceau électrique pour chrochet d'attelage conforme à la norme DIN/ISO 1724 prise 12-V.	CZ
NL	Montage-handleiding elektrokabelset voor trekhaak met 12-P contactdoos vlg. DIN/ISO norm 1724.	DK
GB	Fitting instructions electric wiring kit tow bar with 12-P socket up to DIN/ISO Norm 1724.	FI
ES	Instrucciones de montaje de kit eléctrico para enganche de remolque con caja de conexiones 12-P según norma DIN/ISO 1724.	GR
IT	Istruzioni di montaggio di set di cavi elettrici per gancio da traino con zoccolo a 12-P conforme alla norma DIN/ISO 1724.	NO
SE	Monteringsanvisningar elkabelsats för dragkrok med 12-P kontaktdosa enligt DIN/ISO norm 1724.	PL
		CZ
		DK
		FI
		GR
		NO
		PL

DE	- Wir weisen ausdrücklich darauf hin, dass eine unsachgemäße und nicht in einer Fachwerkstatt durchgeführte Montage einen Verzicht auf Entschädigung jeglicher Art insbesondere bezüglich des Produkthaftpflichtrechts zur Folge hat	- Technische Änderungen vorbehalten. - Widerstand nur gemäß der Tabelle auf dem Anhänger verwenden.
FR	- Il est expressément prévu qu' on ne saurait se prévaloir d'un quelconque préjudice contractuel ou rédhitoire si le montage avait été fait en dépit des dites instructions ou dans un garage ne disposant pas des équipements adéquats.	- Sous réserve de modifications techniques. - Ne excédez pas la charge maximale, indiquée dans le tableau.
NL	- Wij wijzen er met nadruk op, dat ondeskundige en niet door een vakkundige werkplaats uitgeoefende montage tot gevolg heeft dat daardoor ieder recht op schadevergoeding, ook op wettelijke aansprakelijkheid inzake producten, vervalt.	- Technische wijzigingen voorbehouden. - Gebruik alleen belasting volgens aansluittabel op het getrokken voertuig.
GB	- We would expressly point out that assembly not carried out properly by a competent installer will result in cancellation of any right to damage compensation, in particular those arising by virtue of the product liability act.	- Contents of these kits and their fitting manuals are subject to alteration without notice, please ensure that these instructions are read and fully understood before commencing installation. - Do not overload circuits; the maximum loads per connection are detailed in this manual.
ES	- El montaje inapropiado y efectuado por personal no cualificado originará la pérdida de todo derecho a indemnización o la expiración de toda responsabilidad civil con respecto al producto.	- Nos reservamos el derecho a efectuar modificaciones técnicas. - Utilice sólo cargas de acuerdo a la tabla de conexión del vehículo remolcado.
IT	- Sottolineiamo espressamente che un montaggio inadeguato ed eseguito da un'officina non specializzata ha come conseguenza il decadere di qualsiasi diritto al risarcimento danni, nonché alla responsabilità legale relativa ai prodotti.	- Ci si riserva il diritto di apportare modifiche tecniche. - Utilizzare esclusivamente un carico conforme alla tabella degli allacci relativa al veicolo in questione.
SE	- Vi påpekar med eftertryck att all rätt till skadeersättning och all laglig ansvarighet förfaller om monteringen inte har utförts på rätt sätt och av en professionell verkstad.	- Tekniska ändringar förbehålles. - Använd endast belastning enligt anslutningstabellen på det dragna fordonet.
CZ	- Vůslovně zdůrazňujeme, že jakákoli montáž, která není provedená ve specializované dílně, má za následek odvolání nároků na kompensaci jakéhokoli druhu, obzvláště vyplývajících ze zákona o odpovědnosti za způsobené škody.	- Změny mohou být provedeny bez oznámení. - Používejte pouze při maximálním nabití podle tabulky na tažném vozidle.
DK	- Vi ønsker at gøre udtrykkeligt opmærksom på at forkert samling, der ikke er udført af et specialiseret værksted, resulterer i bortfaldelse af kompenseringskrav af alle slags, i særdeles krav der måtte opstå omkring det lovligtige ansvar.	- Kan ændres uden varsel. - Brug kun den maksimale belastning, i overensstemmelse med forbindelsestabelen for bugserede køretøjer.
FI	- Korostamme, että kaikki oikeudet vahinkokorvaukseen kuten myös valmistajan laillinen vastuu raukeavast, mikäli asennusta ei ole toteutettu oikealla tavalla eikä ammattitaitoisen asiantuntijan toimesta.	- Oikeus tekniisiin muutoksiin ilman erillistä huomautusta pidetään. - Kuormita työvirtapiiriä ainoastaan hinattavan ajoneuvon kytkentäkaavion mukaisesti.
GR	- Επισημαίνουμε κατηγορηματικά ότι οποιαδήποτε εσφαλμένη συναρμολόγηση, η οποία δεν έχει πραγματοποιηθεί ειδικό εργαστήριο θα οδηγήσει σε αποποίηση των αξιώσεων επιβολής αποζημιώσεων οποιαδήποτε είδους, ειδικά όσα προκύπτουν από το νόμο ευθύνης προϊόντων.	- Μπορεί να τροποποιηθεί χωρίς προηγούμενη ειδοποίηση. - Χρησιμοποιείτε μόνο μέγιστο ηλεκτρικό φορτίο σύμφωνα με τον πίνακα σύνδεσης στο ρυμολκούμενο όχημα.
NO	- Vi påpeker ettertrykkelig at all rett til skadeerstatning og rettslig ansvar forfaller dersom monteringen ikke er blitt utført på riktig måte og av et profesjonelt verksted.	- Tekniske endringer forbeholdes. - Overskrid ikke grensene anvist i tilkoblingstabellen på tilhengeren eller det tilkoblede kjøretøyet.
PL	- Chcielibyśmy wyraźnie zaznaczyć, iż wszelki nieprawidłowy montaż, który nie jest wykonywany w specjalistycznym warsztacie pociąga za sobą utratę możliwości dochodzenia wszelkiego typu roszczeń, w szczególności tych wynikających z odpowiedzialności producenta za swój produkt.	- Podlega zmianom bez powiadomienia. - Używać tylko takiego maksymalnego obciążenia które wynika z tabliczki połączeń holowanego pojazdu.

Einzelteilliste

Liste de pièces

Onderdelenlijst

Part list

Lista de componentes

Elenco componenti

Dellista

Seznam dílů

Del-liste

Osaluettelo

Κατάλογος εξαρτημάτων

Delliste

Lista części

DE

FR

NL

GB

ES

IT

SE

CZ

DK

FI

GR

NO

PL

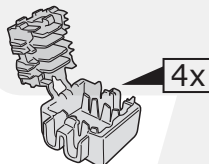
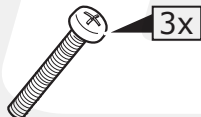
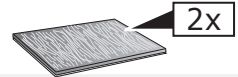
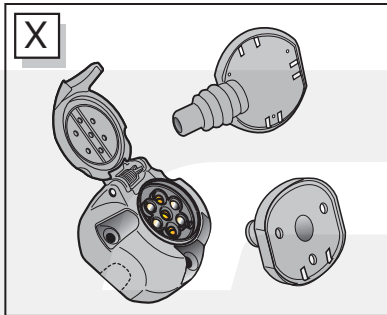
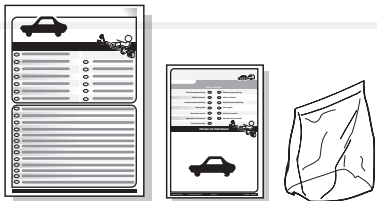
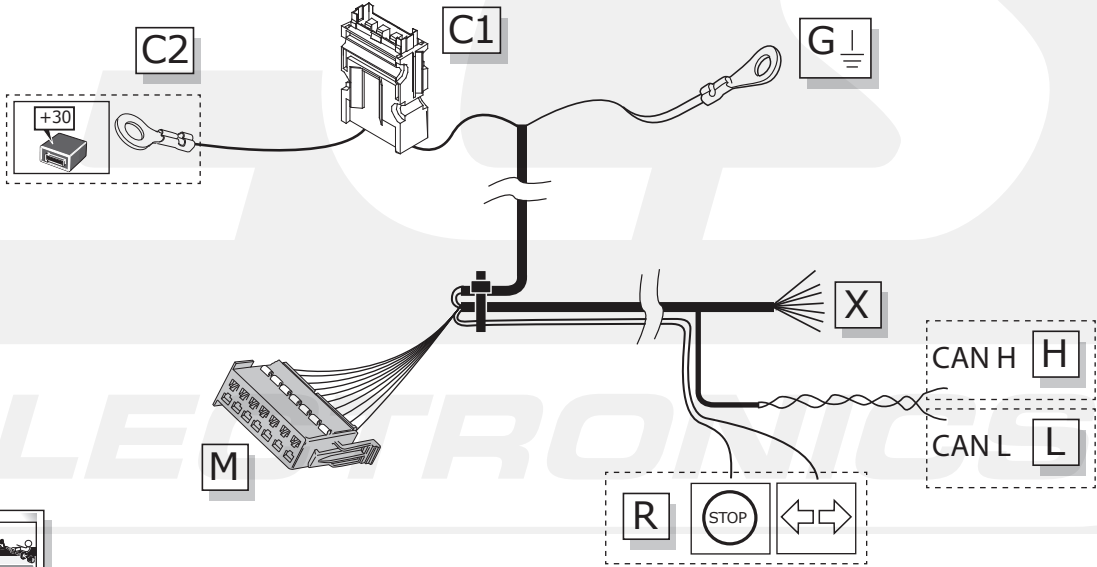

INFO

- (DE) Fragen Sie erst den Händler, ob ein Erweiterungsset für Anhängerkupplung plus Wärmeisolation (wegen Kühlung) für Ihr Fahrzeug verfügbar ist.
- (FR) Renseignez-vous d'abord auprès du concessionnaire pour savoir si un kit d'extension pour crochet de remorquage avec isolation thermique (dans le cadre du refroidissement) s'applique à votre véhicule.
- (NL) Eerst informeren bij de dealer of een uitbreidingsset voor trekhaak plus warmteisolatie (ivm koeling) van toepassing is voor uw voertuig.
- (GB) First inquire at the dealer if an expansion set for a towing hook plus heat insulation (in connection with cooling) applies to your vehicle.
- (ES) Consulte al concesionario si al instalar enganche de remolque es necesario equipar su vehículo con un sistema de aislamiento térmico adicional (conectado al sistema de refrigeración).
- (IT) È necessario informarsi preventivamente presso il concessionario se è possibile applicare al veicolo un set supplementare per il gancio di trazione e gli isolamenti per il calore (in relazione al raffreddamento).
- (SE) Ska du först rådfråga din återförsäljare om extrautrustning med dragkrok plus värmeisolering (i anslutning till kylning) tillämpas för ditt fordon.
- (CZ) Se nejprve u prodejce dotážete, lze-li pro vaše vozidlo použít rozšiřující sadu s tažným hákem a tepelnou izolací (společně s chlazením).
- (DK) Skal du først spørge forhandleren, om der findes et udvidelsessæt med trækrog plus varmeisolering (i forbindelse med køling) til din bil.
- (FI) Kysy ensin jälleenmyyjältä, sopiiko ajoneuvoon laajennussarja, jossa on hinauskoukku ja lämpöeristys (jäähdytysjärjestelmässä).
- (GR) Ρωτήστε τον αντιπρόσωπο εάν εφαρμόζεται στο όχημά σας σετ εκτόνωσης με γάντζο ρυμούλκησης και θερμομόνωση (σε σχέση με την ψύξη).
- (NO) Må man høre med forhandleren om det finnes et sett med krok og varmeisolasjon (i tilfelle nedkjøling) som er tilpasset kjøretøyet.
- (PL) Najpierw należy dowiedzieć się u dealera, czy hak holowniczy z izolacją cieplną (połączoną z chłodzeniem) jest dostępny dla pojazdu.
- (RU) Проинформируйте у дилера о возможности применения для вашего автомобиля дополнительного комплекта для сцепного крюка и теплоизоляции (в связи с охлаждением).

INFO

	BK	BN	BU	GY	GN	WH	YE	OG	PE	PI	RD
(DE)	Schwarz	Braun	Blau	Grau	Grün	Weiß	Gelb	Orange	Violett	Rosa	Rot
(FR)	Noir	Marron	Blue	Gris	Vert	Blanc	Jaune	Orange	Violet	Rose	Rouge
(NL)	Zwart	Bruin	Blauw	Grijs	Groen	Wit	Geel	Oranje	Paars	Roze	Rood
(GB)	Black	Brown	Blue	Grey	Green	White	Yellow	Orange	Purple	Pink	Red
(ES)	Negro	Marrón	Azul	Gris	Verde	Blanco	Amarillo	Naranja	Morado	Rosa	Rojo
(IT)	Nero	Marrone	Blu	Grigio	Verde	Bianco	Giallo	Arancione	Viola	Rosa	Rosso
(SE)	Svart	Brun	Blå	Grå	Grön	Vit	Gul	Orange	Lila	Rosa	Röd
(CZ)	Černá	Hnědá	Modrá	Šedá	Zelená	Bílá	Žlutá	Oranžová	Fialová	Růžová	Červená
(DK)	Sort	Brun	Blå	Grå	Grøn	Hvid	Gul	Orange	Lilla	Pink	Rød
(FI)	Musta	Ruskea	Sininen	Harmaa	Vihreä	Valkoinen	Keltainen	Oranssi	Purppura	Vaaleanpunainen	Punainen
(GR)	Μαύρο	Καφέ	Μπλε	Γκρι	Πράσινο	Λευκό	Κίτρινο	Πορτοκαλί	Μοβ	Ροζ	Κόκκινο
(NO)	Svart	Brun	Blå	Grå	Grønn	Hvit	Gul	Oransje	Lilla	Rosa	Rød
(PL)	Czarny	Brązowy	Niebieski	Szary	Zielony	Biały	Żółty	Pomarańczowy	Purpurowy	Różowy	Czerwony

INFO

BMW 5 Series F10, F11
BMW 7 Series F01, F02



Pag. 4

BMW X3 Series F25



Pag. 7

BMW 1 Series E81, E82, E87, E88
BMW 3 Series E90, E91, E92, E93
BMW 5 Series E60, E61, F07
BMW 7 Series E65, E66
BMW X1 Series E84
BMW X5 Series E70
BMW X6 Series E71



Pag. 10

BMW 1 Series E81, E82, E87, E88
BMW 3 Series E90, E91, E92, E93
BMW 5 Series E60, E61, F07
BMW 7 Series E65, E66
BMW X1 Series E84
BMW X5 Series E70
BMW X6 Series E71



Pag. 13

BMW 1 Series F20, F21



Pag. 16

BMW 3 Series F30, F31



Pag. 19

ROUTING

BMW 5 Series F10, F11
BMW 7 Series F01, F02

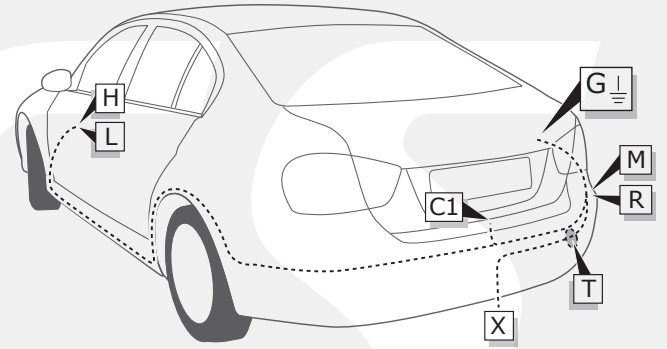

1

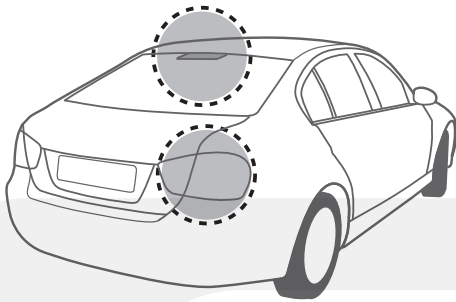
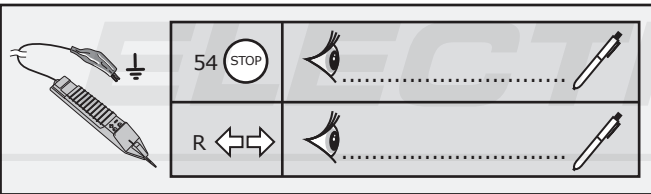

2

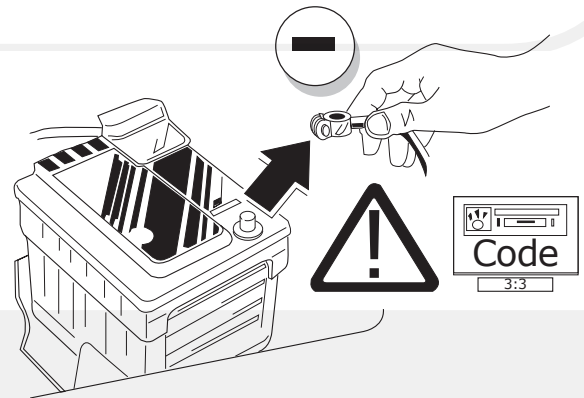

3

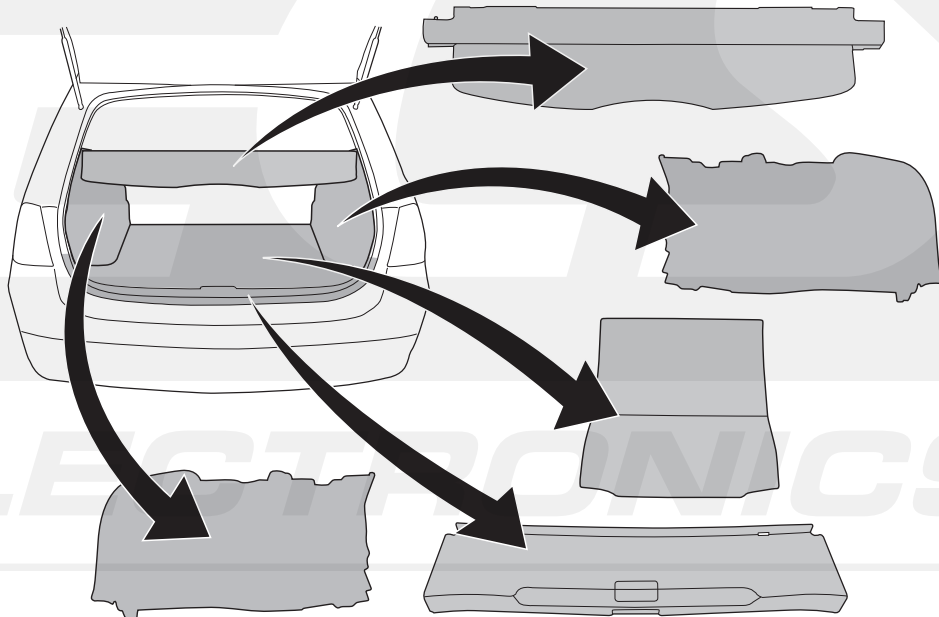

4

INFO

X



2

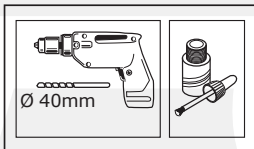

1

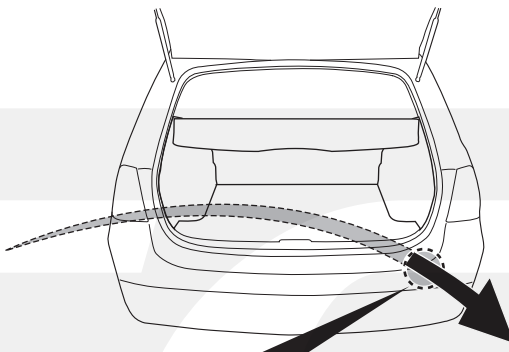

INFO

- (DE) Anschluss Steckdose
- (FR) Connection de la prise
- (NL) Contactdoos aansluiting
- (GB) Socket connection
- (ES) Conexión de la caja de enchufe
- (IT) Allaccio zoccolo
- (SE) Anslutning kontaktdosa
- (CZ) Objímkový konektor
- (DK) Stikdåse forbindelse
- (FI) Pistorasia liitäntä
- (GR) Υποδοχή σύνδεσης
- (NO) Tilkobling koblingsboks
- (PL) Połączenie przez gniazdo



Pag. 25

5

1

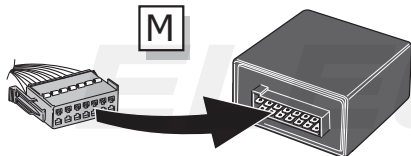

2

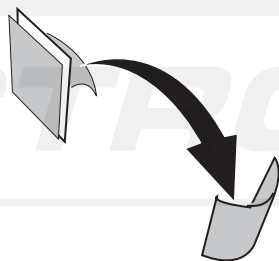

3

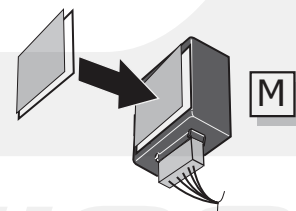

4

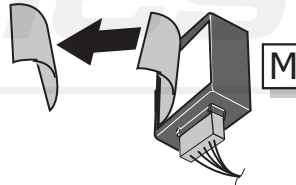

6

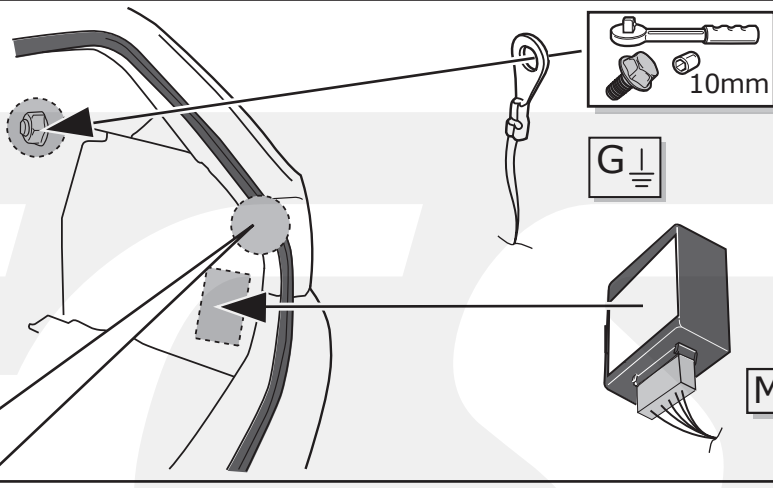
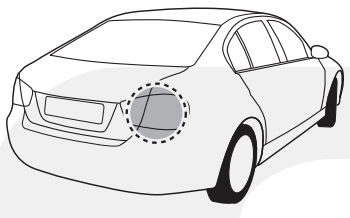

INFO

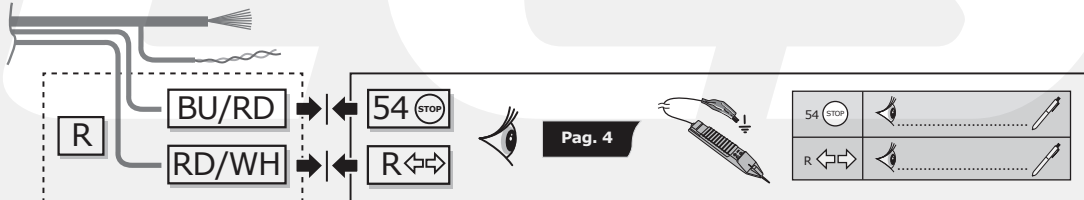

Pag. 4

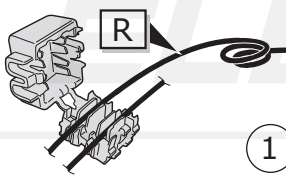

1

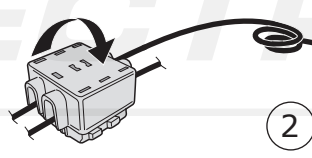

2

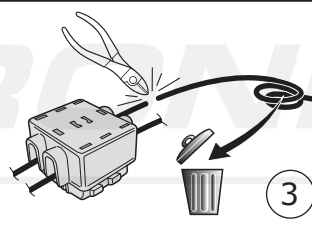

3

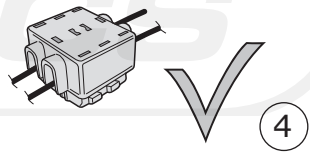

4

7

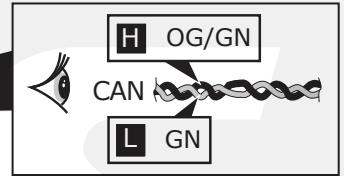
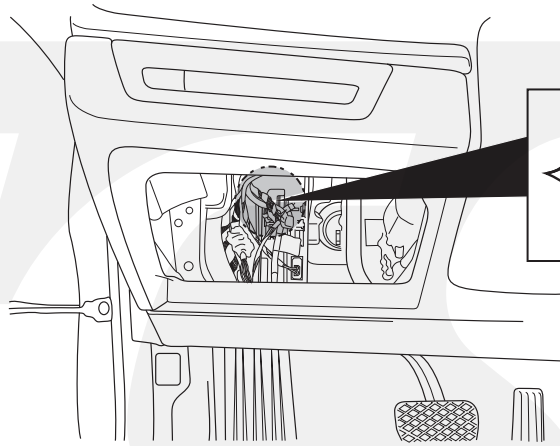
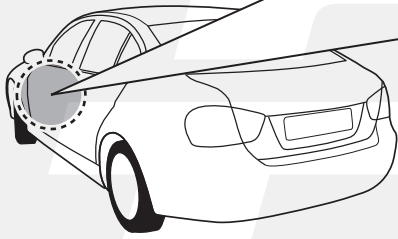

8

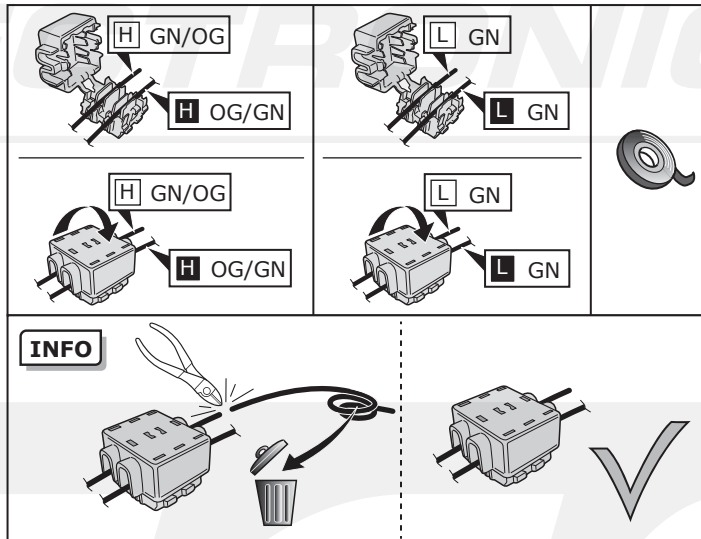
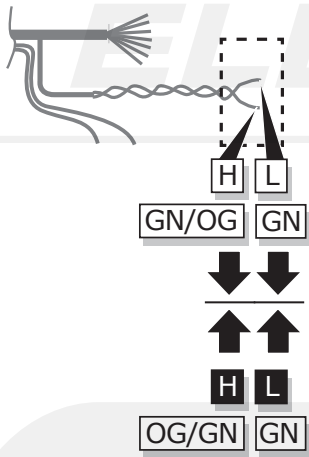

INFO

Pag. 3

DE Farben	CZ Barevným
FR Couleurs	DK Farverne
NL Kleuren	FI Coloria
ES Colours	GR χρώματα
PT Colores	NO Farget
IT Colori	PL Kolorować
SE Färgar	

9



ELECTRONICS

BMW X3 Series F25

ROUTING

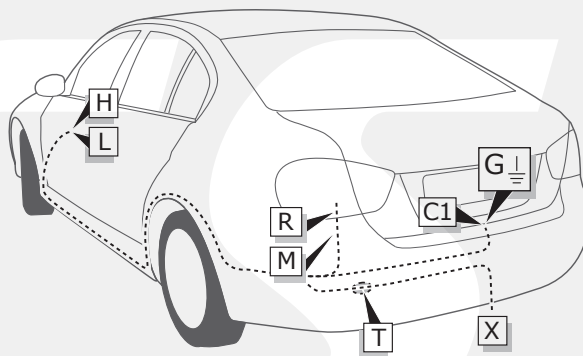

10

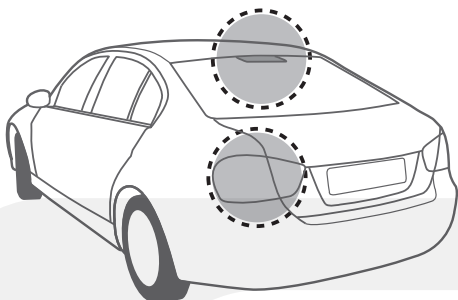
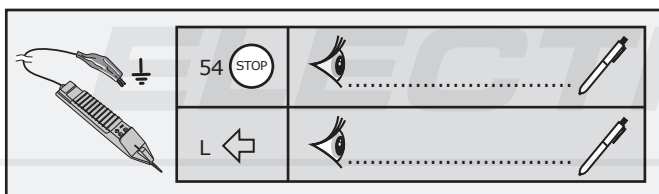

11

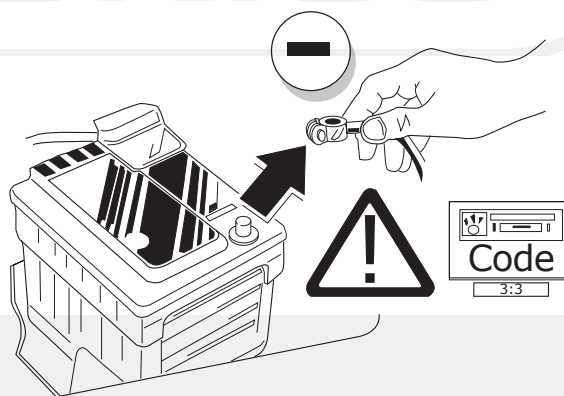

12

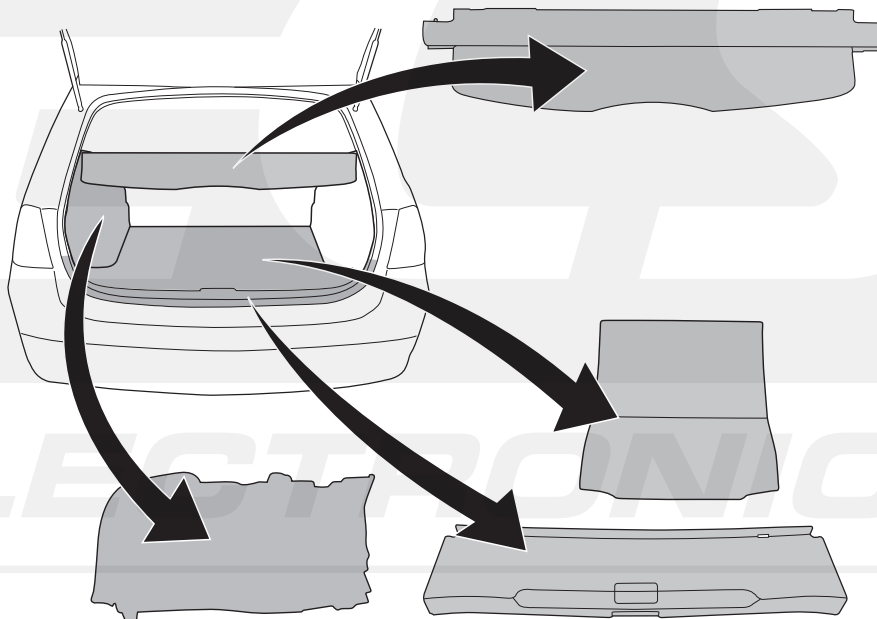

13

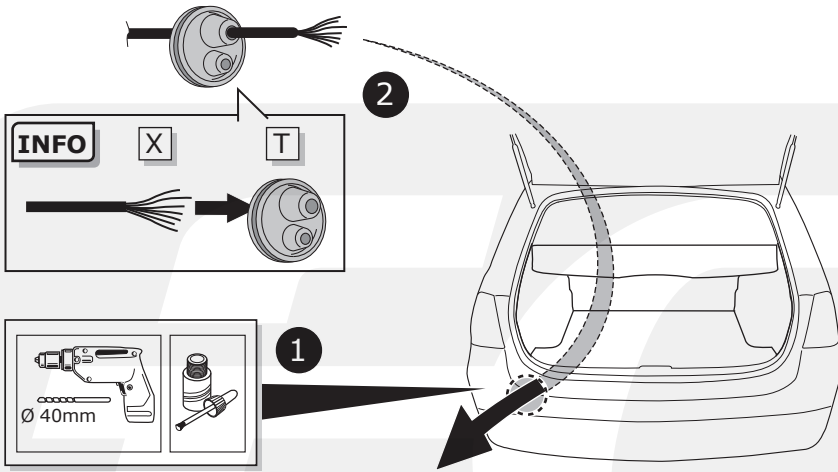

INFO

- (DE) Anschluss Steckdose
- (FR) Connection de la prise
- (NL) Contactdoos aansluiting
- (GB) Socket connection
- (ES) Conexión de la caja de enchufe
- (IT) Allaccio zoccolo
- (SE) Anslutning kontaktdosa
- (CZ) Objímkový konektor
- (DK) Stikdåse forbindelse
- (FI) Pistorasia liitäntä
- (GR) Υποδοχή σύνδεσης
- (NO) Tilkobling koblingsboks
- (PL) Połączenie przez gniazdo



Pag. 25

14

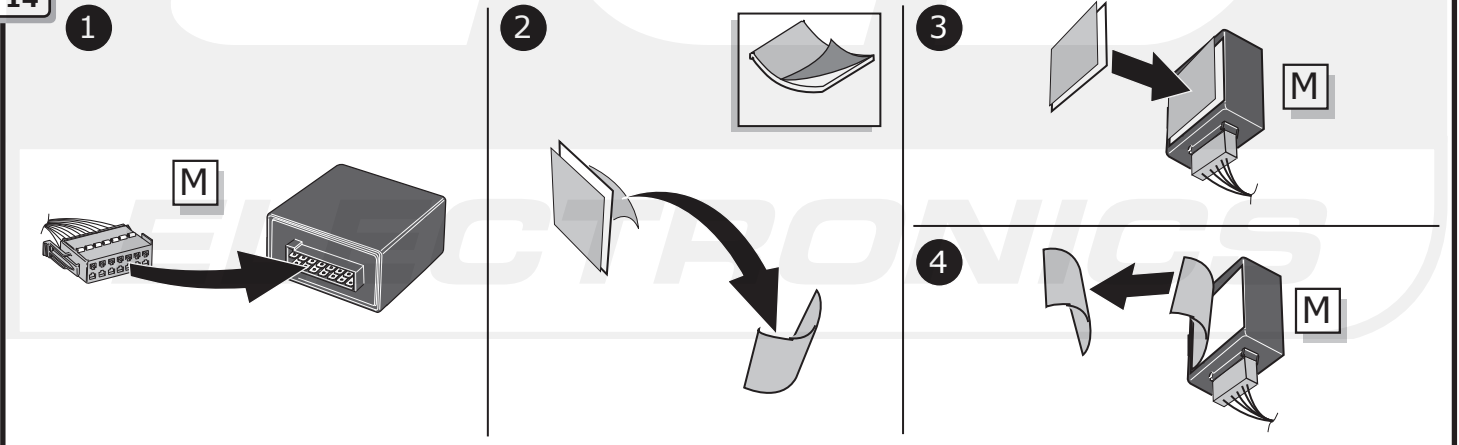

15

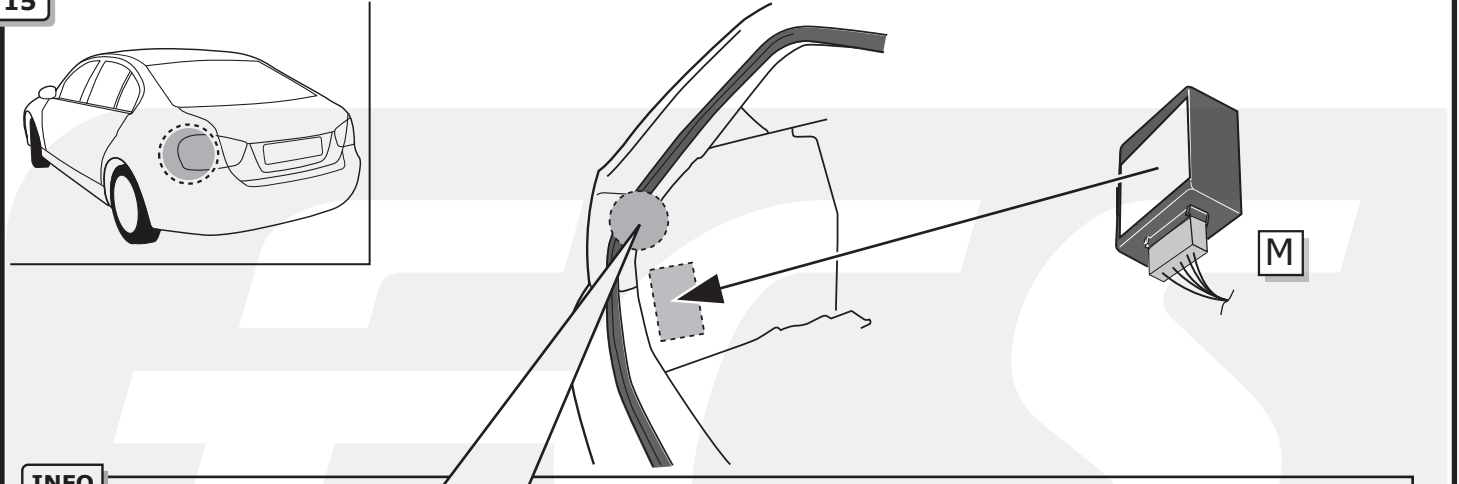

INFO

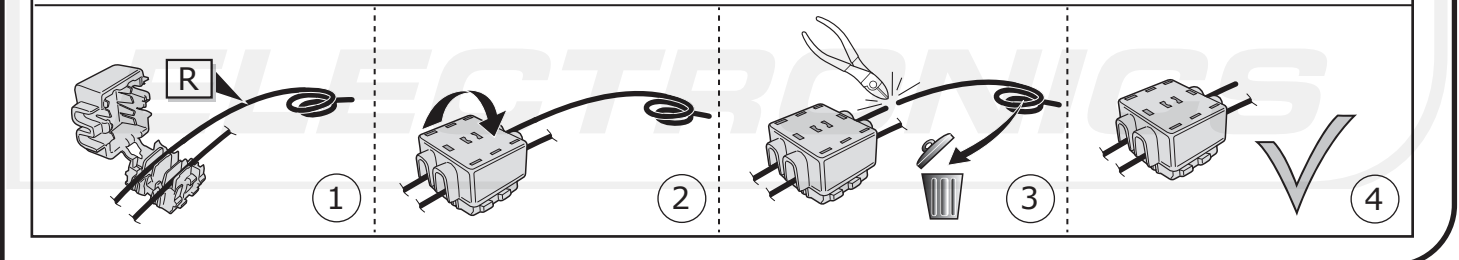

16

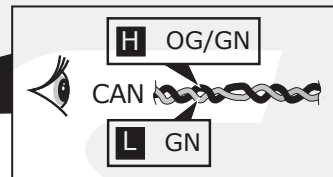
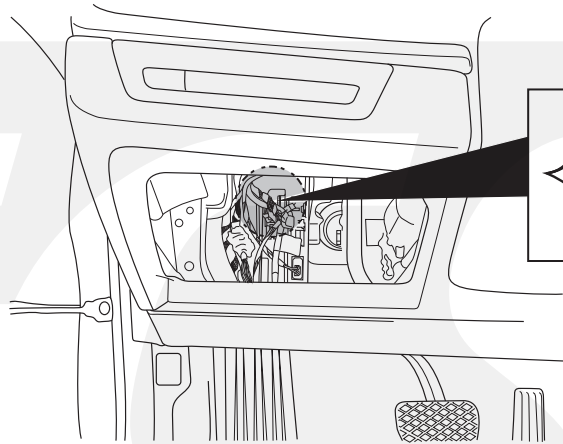
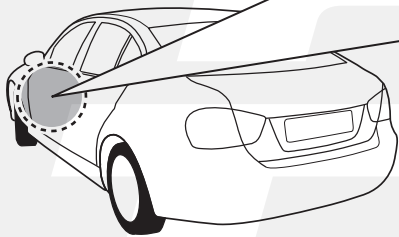

17

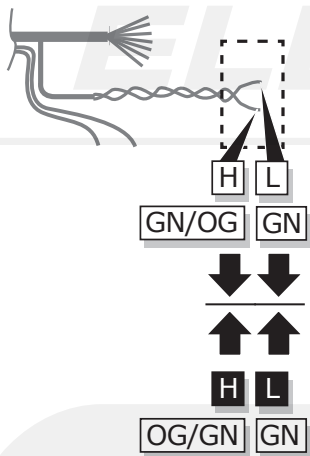

INFO

INFO

Pag. 3

DE Farben	CZ Barevným
FR Couleurs	DK Farverne
NL Kleuren	PT Coloria
GB Colours	GR χρώματα
ES Colores	NO Farger
IT Colori	PL Kolorowac
SE Färgar	

18

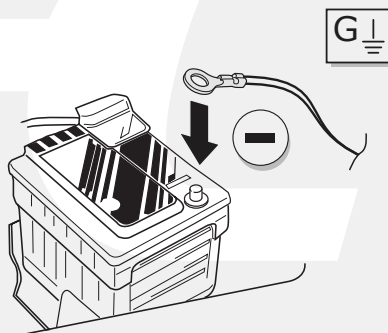

19



Pag. 22

ROUTING

BMW 1 Series E81, E82, E87, E88
BMW 3 Series E90, E91, E92, E93
BMW 5 Series E60, E61, F07
BMW 7 Series E65, E66
BMW X1 Series E84
BMW X5 Series E70
BMW X6 Series E71

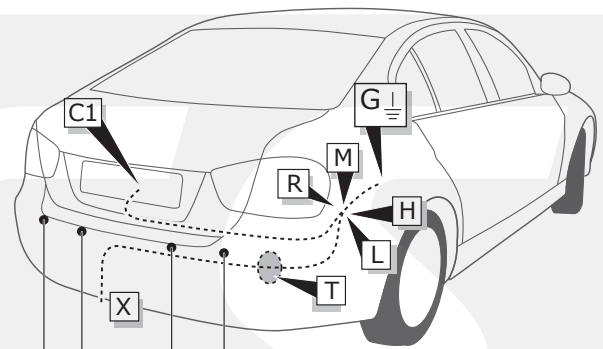

PARK DISTANCE CONTROL

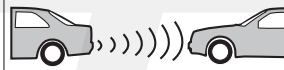

20

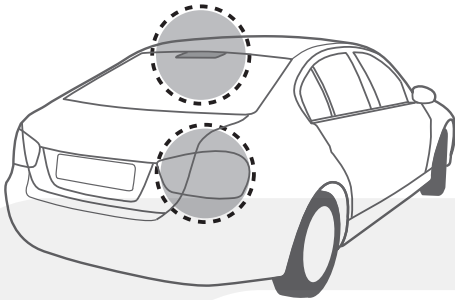
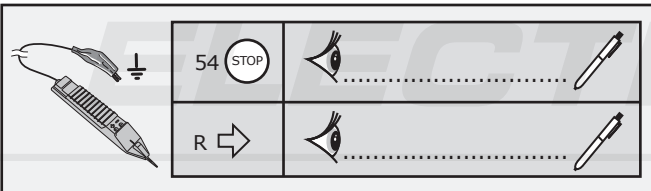

21

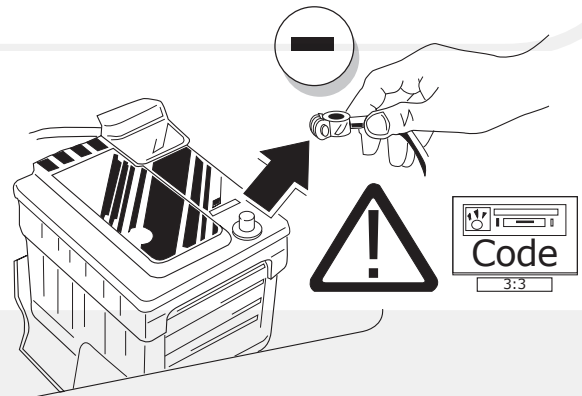

22

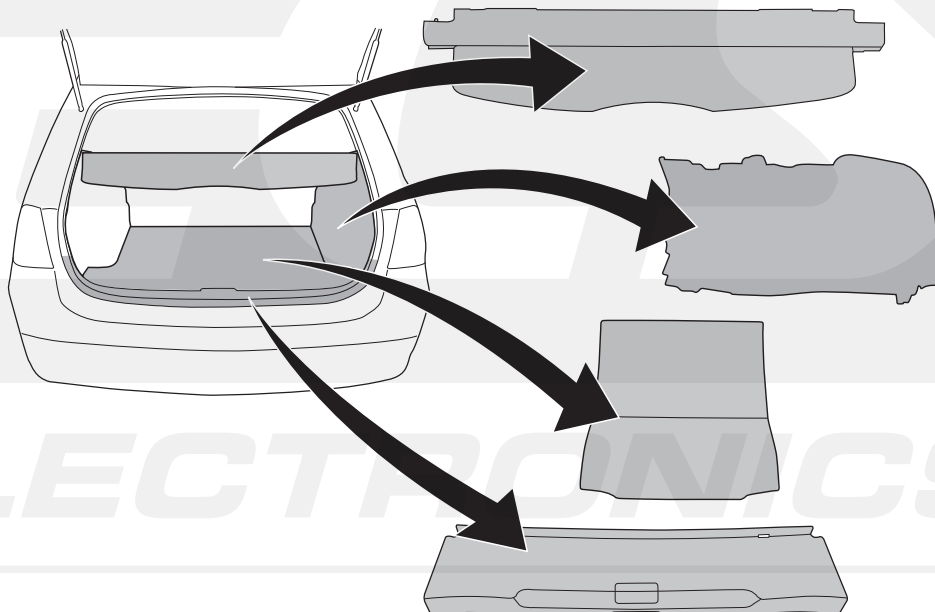

23

INFO

X

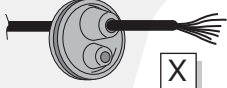
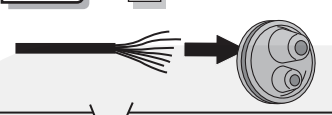

2

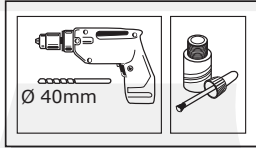

1

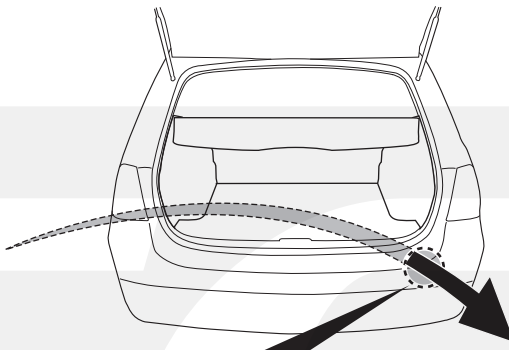

INFO

- (DE) Anschluss Steckdose
- (FR) Connection de la prise
- (NL) Contactdoos aansluiting
- (GB) Socket connection
- (ES) Conexión de la caja de enchufe
- (IT) Allaccio zoccolo
- (SE) Anslutning kontaktdosa
- (CZ) Objímkový konektor
- (DK) Stikdåse forbindelse
- (FI) Pistorasia liitäntä
- (GR) Υποδοχή σύνδεσης
- (NO) Tilkobling koblingsboks
- (PL) Połączenie przez gniazdo



Pag. 25

24

1

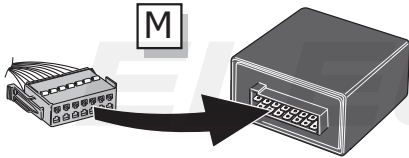

2

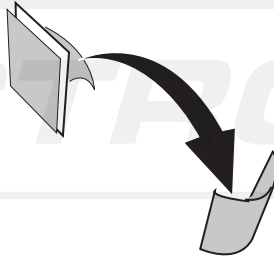

3

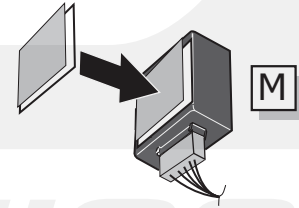

4

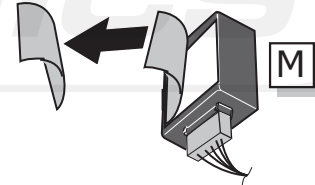

25

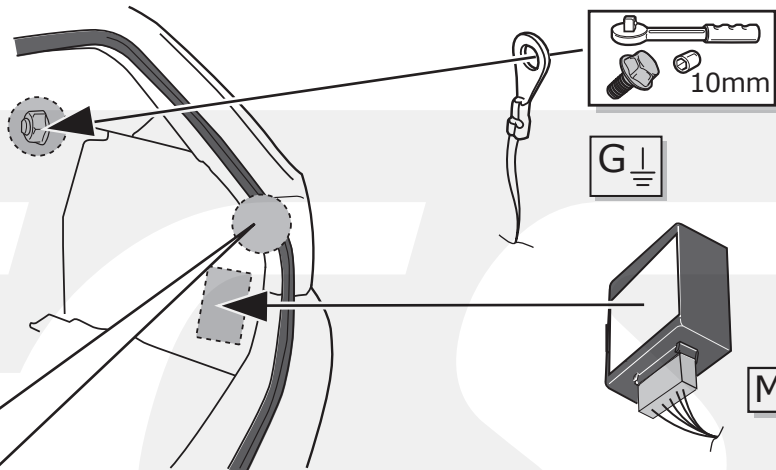
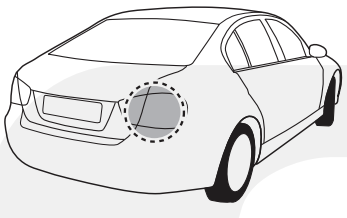

INFO

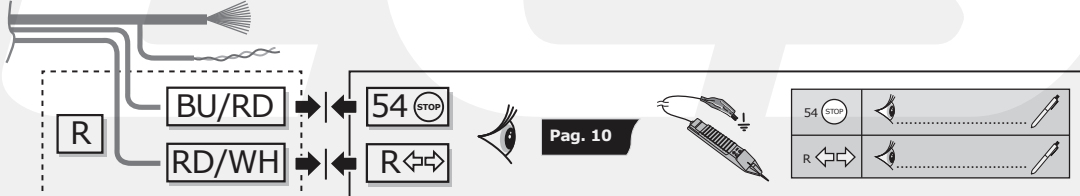

Pag. 10

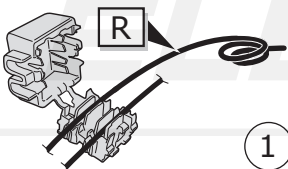

1

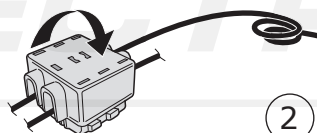

2

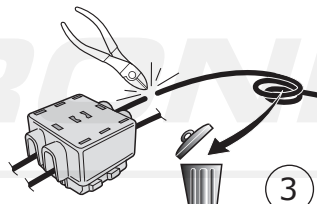

3

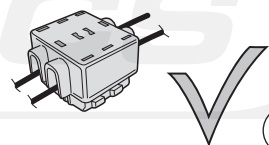

4

26

OPTION 1: E60 / E61

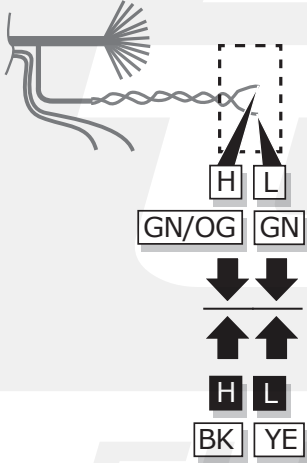
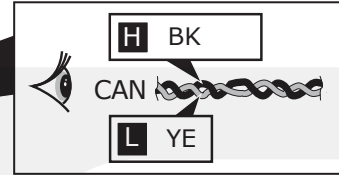
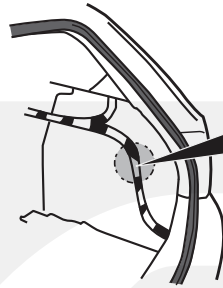
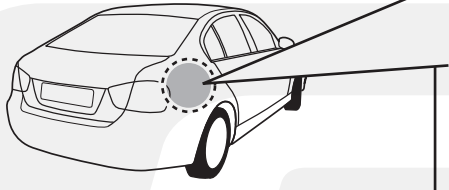

INFO		

INFO

Pag. 3

☉ Farben	☉ Barevným
☉ Couleurs	☉ Farverne
☉ Kleuren	☉ Coloria
☉ Colours	☉ χρώματα
☉ Colores	☉ Farget
☉ Colori	☉ Kolorować
☉ Färgar	

27

OPTION 2: Other models

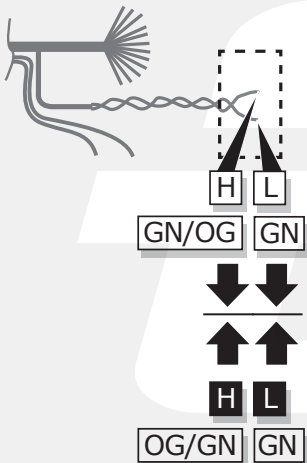
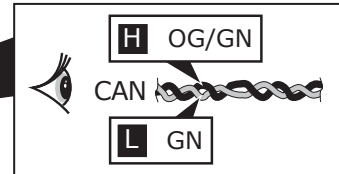
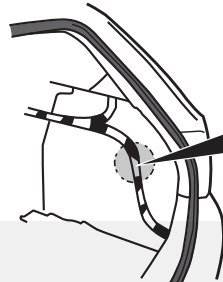
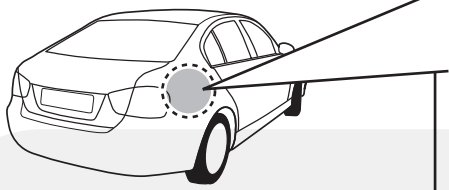

INFO		

INFO

Pag. 3

☉ Farben	☉ Barevným
☉ Couleurs	☉ Farverne
☉ Kleuren	☉ Coloria
☉ Colours	☉ χρώματα
☉ Colores	☉ Farget
☉ Colori	☉ Kolorować
☉ Färgar	

28



Pag. 22

ROUTING

BMW 1 Series E81, E82, E87, E88
BMW 3 Series E90, E91, E92, E93
BMW 5 Series E60, E61, F07
BMW 7 Series E65, E66
BMW X1 Series E84
BMW X5 Series E70
BMW X6 Series E71

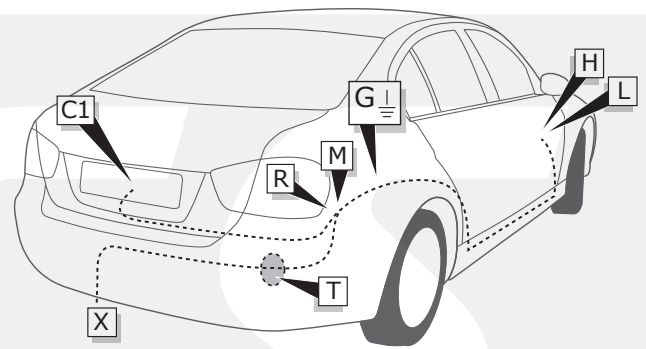

29

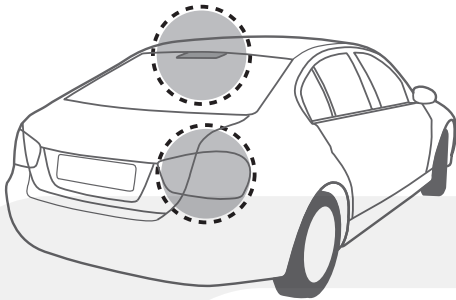
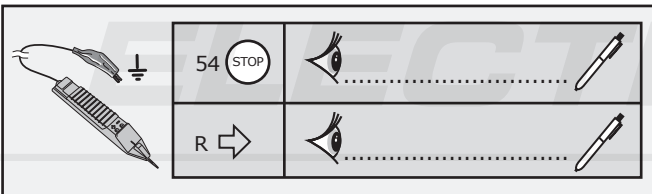

30

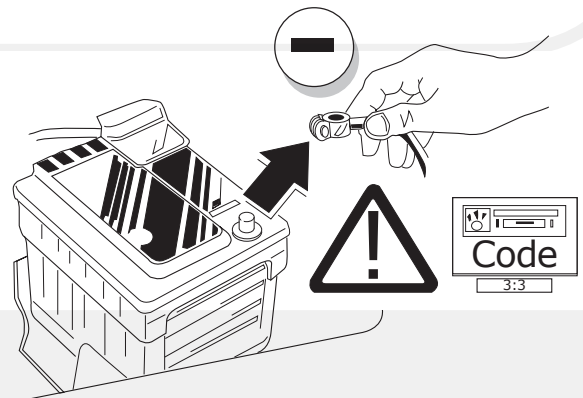

31

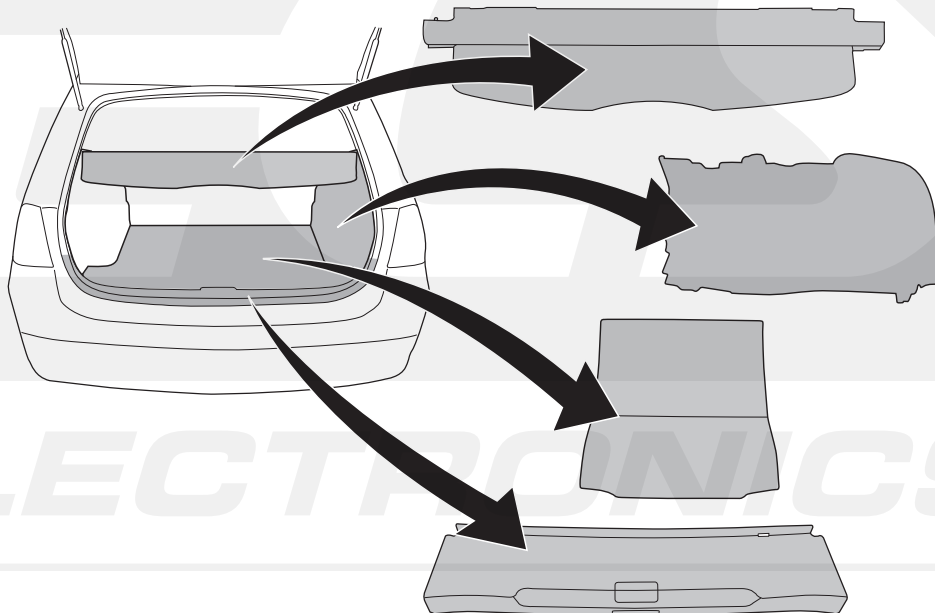

32

INFO

X



2

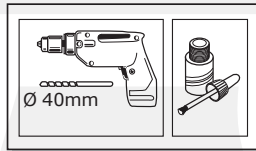

1

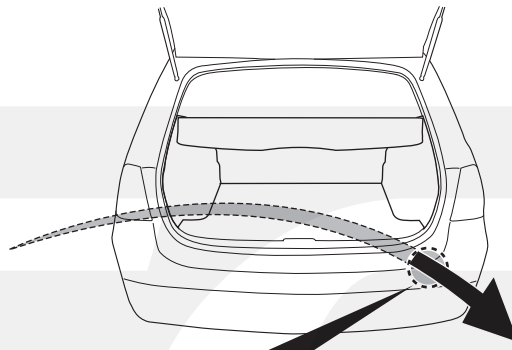

INFO

- (DE) Anschluss Steckdose
- (FR) Connection de la prise
- (NL) Contactdoos aansluiting
- (GB) Socket connection
- (ES) Conexión de la caja de enchufe
- (IT) Allaccio zoccolo
- (SE) Anslutning kontaktdosa
- (CZ) Objímkový konektor
- (DK) Stikdåse forbindelse
- (FI) Pistorasia liitäntä
- (GR) Υποδοχή σύνδεσης
- (NO) Tilkobling koblingsboks
- (PL) Połączenie przez gniazdo



Pag. 25

33

1

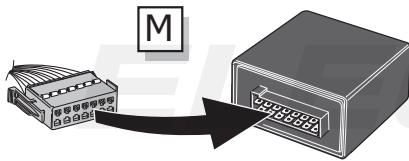

2

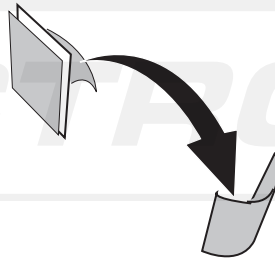

3

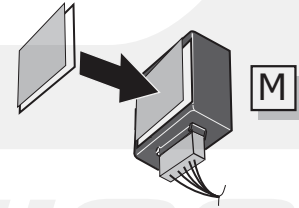

4

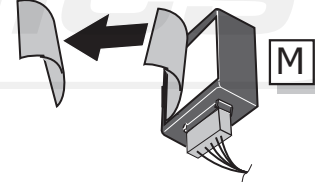

34

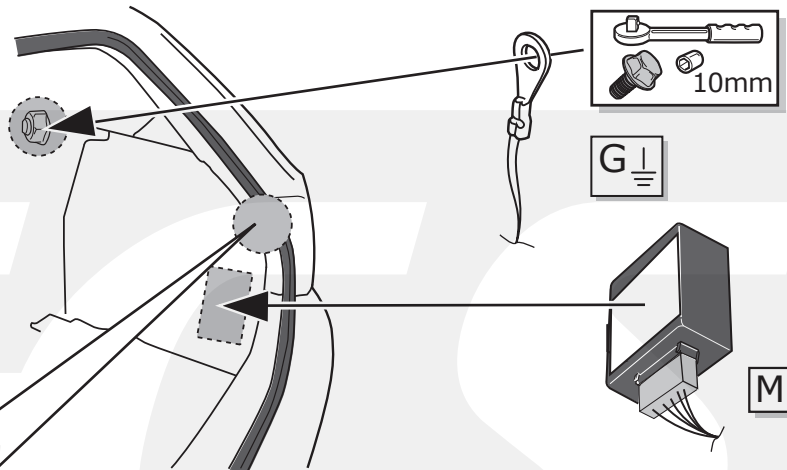
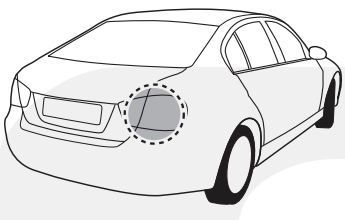

INFO

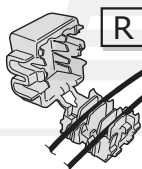
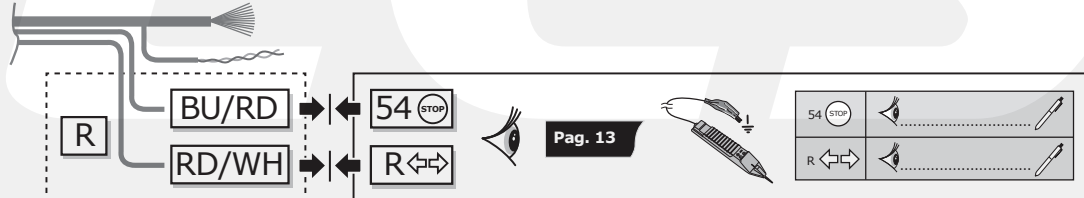

1

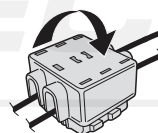

2

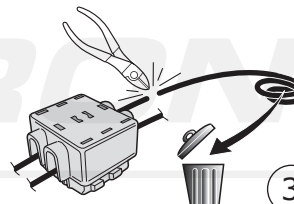

3

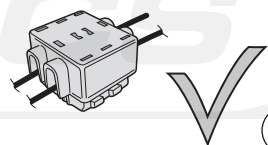

4

35

OPTION 1: E60 / E61

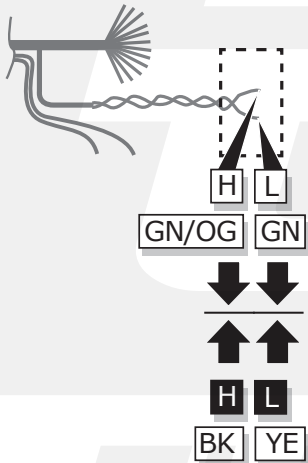
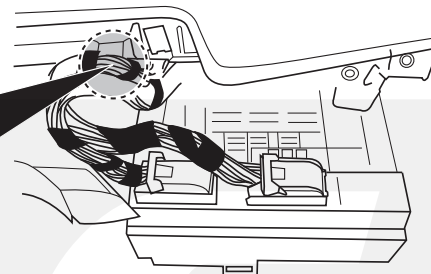
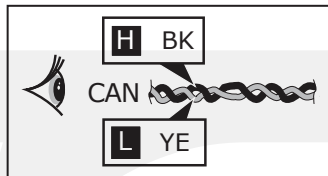
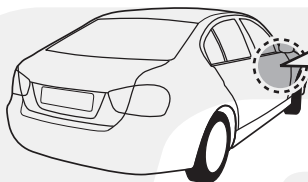

INFO		

INFO

Pag. 3

☉ Farben	☉ Barevným
☉ Couleurs	☉ Farverne
☉ Kleuren	☉ Coloria
☉ Colours	☉ χρώματα
☉ Colores	☉ Farget
☉ Colori	☉ Kolorować
☉ Färgar	

36

OPTION 2: Other models

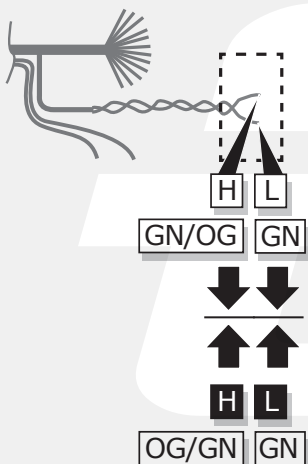
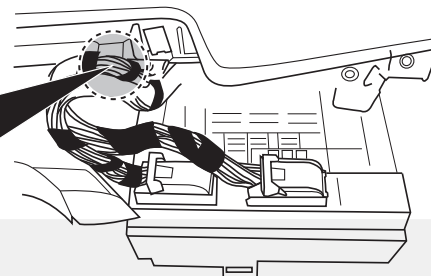
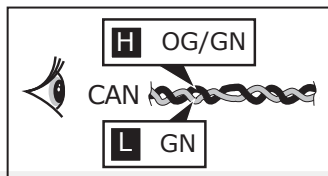
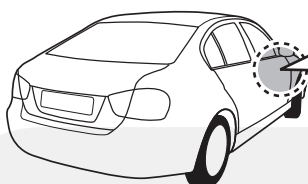

INFO		

INFO

Pag. 3

☉ Farben	☉ Barevným
☉ Couleurs	☉ Farverne
☉ Kleuren	☉ Coloria
☉ Colours	☉ χρώματα
☉ Colores	☉ Farget
☉ Colori	☉ Kolorować
☉ Färgar	

37



Pag. 22

BMW 1 Series F20, F21

INFO



without PDC cut off function

PARK DISTANCE CONTROL



PARK DISTANCE CONTROL



ROUTING

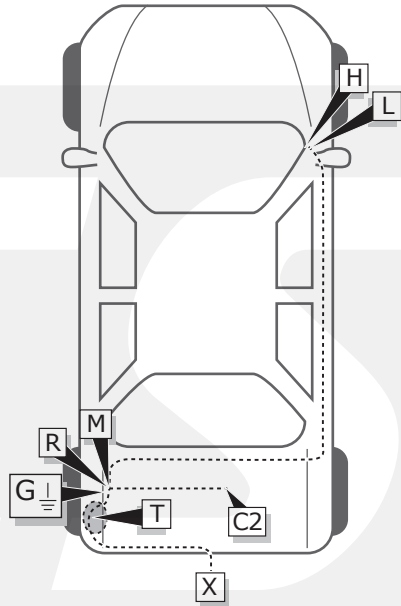

38

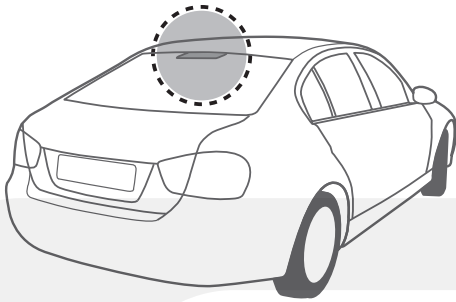

39

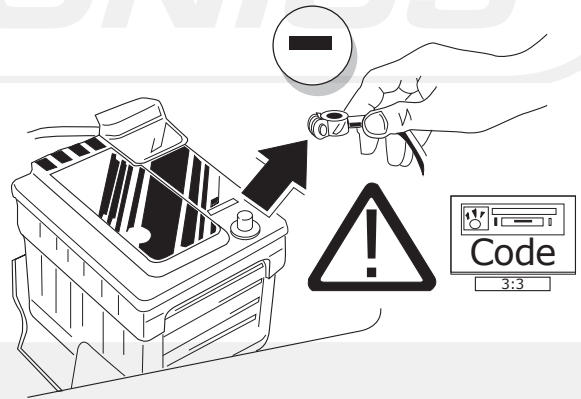

40

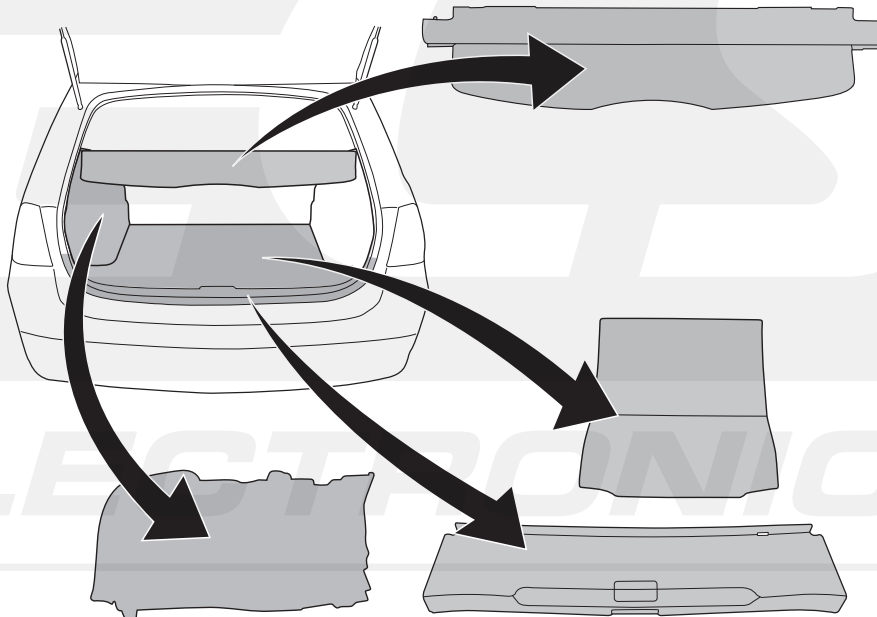

41

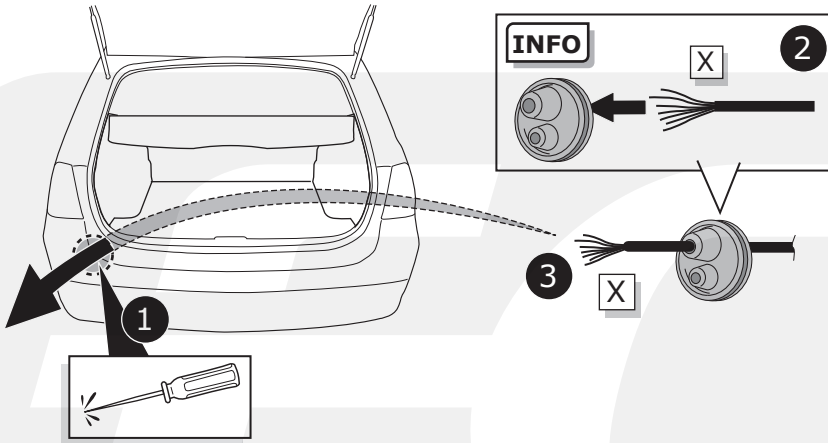

INFO

- (DE) Anschluss Steckdose
- (FR) Connection de la prise
- (NL) Contactdoos aansluiting
- (GB) Socket connection
- (ES) Conexión de la caja de enchufe
- (IT) Allaccio zoccolo
- (SE) Anslutning kontaktdosa
- (CZ) Objímkový konektor
- (DK) Stikdåse forbindelse
- (FI) Pistorasia liitäntä
- (GR) Υποδοχή σύνδεσης
- (NO) Tilkobling koblingsboks
- (PL) Połączenie przez gniazdo



Pag. 25

42

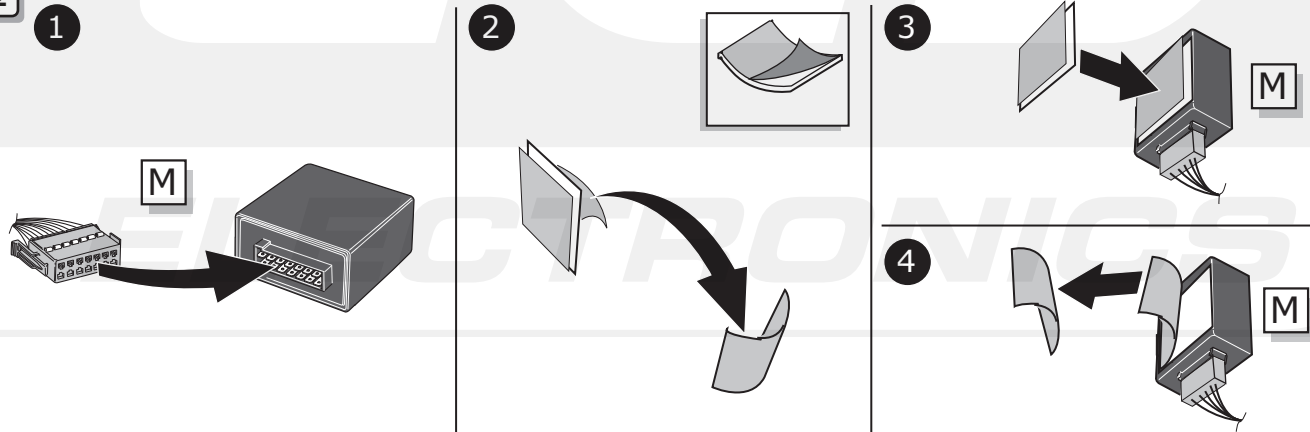

43

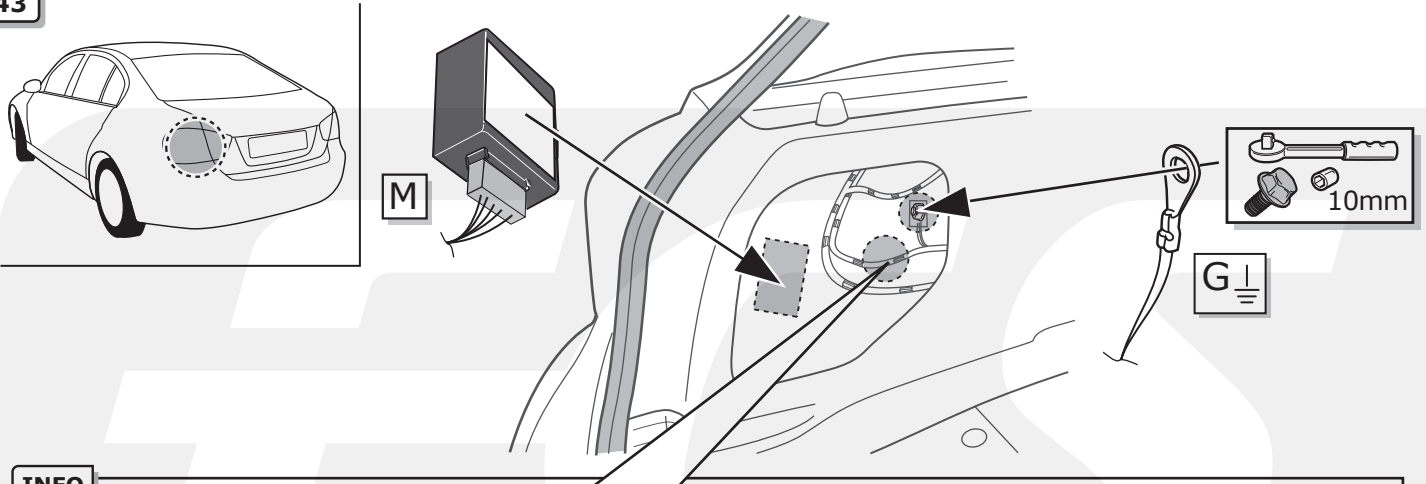

INFO

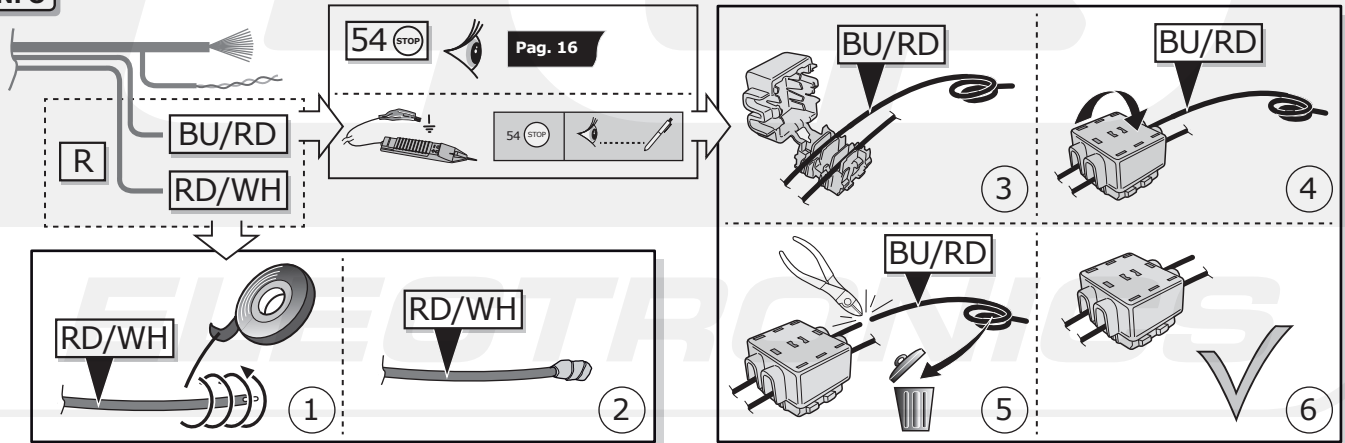

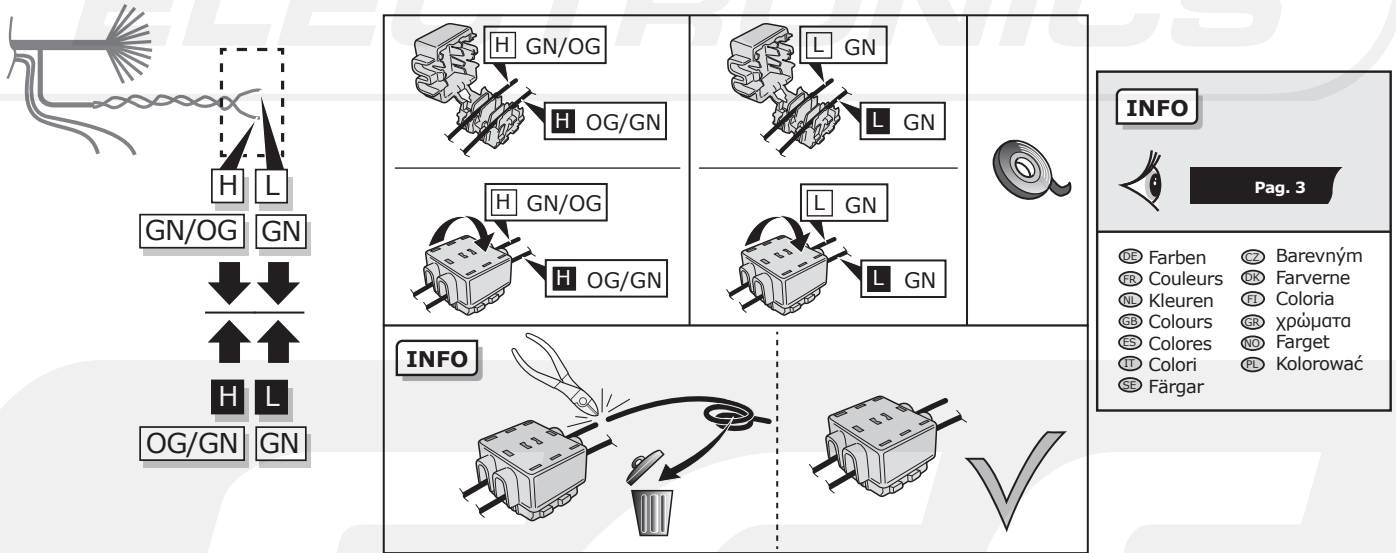
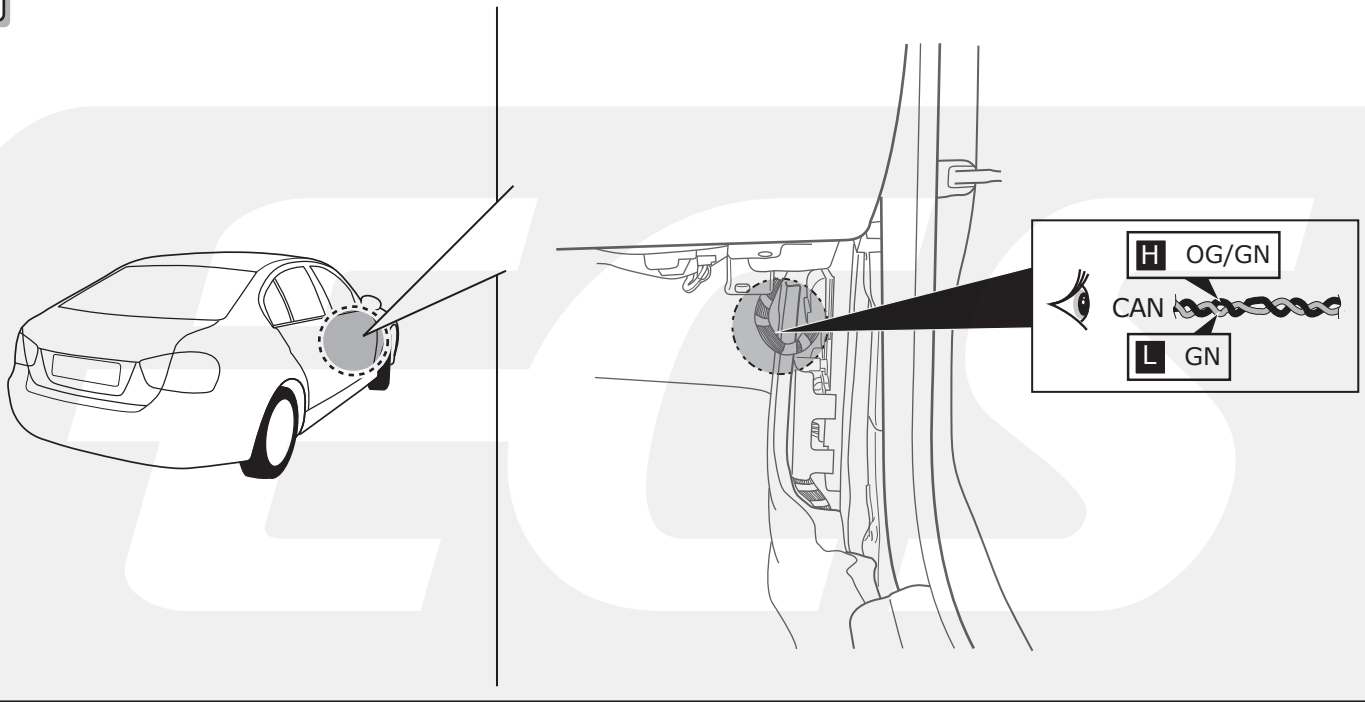

BMW 3 Series F30, F31

ROUTING

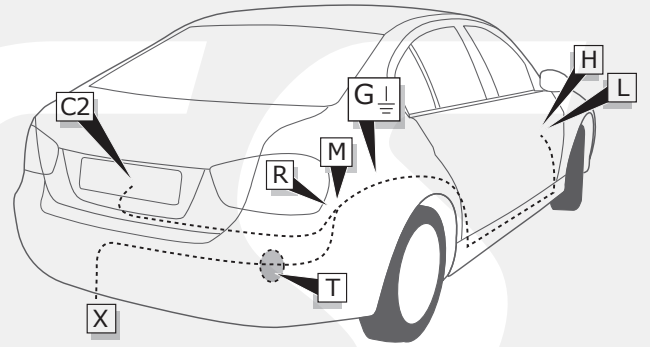

47

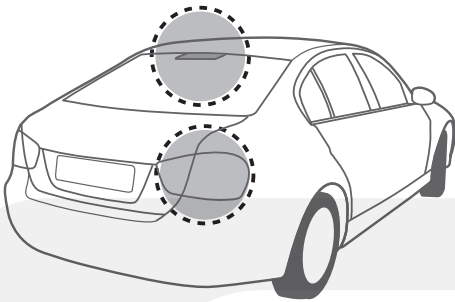
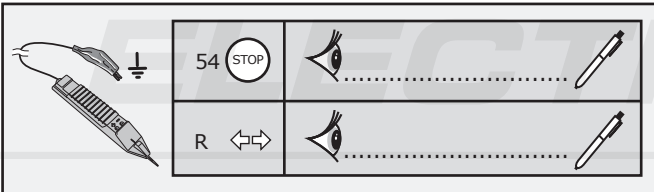

48

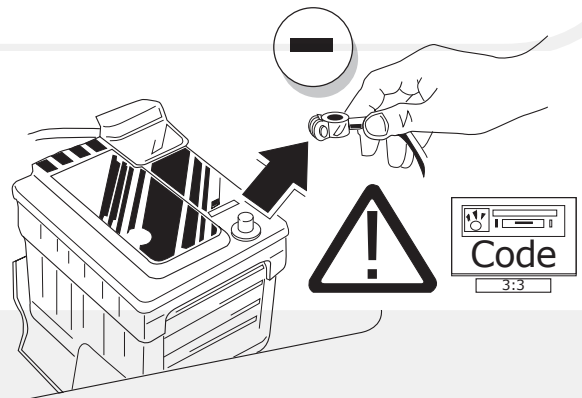

49

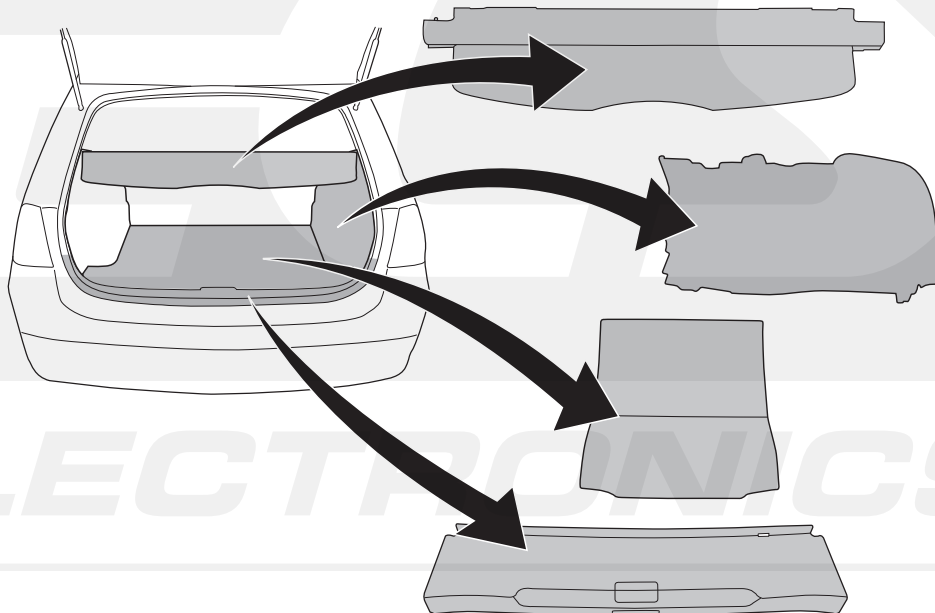

50

INFO

X

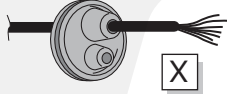

2

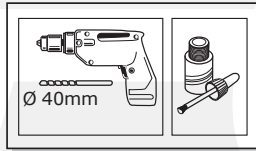

1

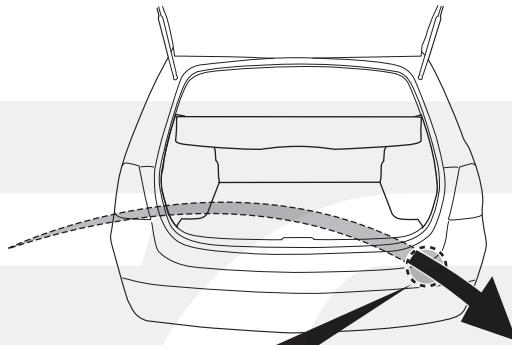

INFO

- DE Anschluss Steckdose
- FR Connection de la prise
- NL Contactdoos aansluiting
- GB Socket connection
- ES Conexión de la caja de enchufe
- IT Allaccio zoccolo
- SE Anslutning kontaktdosa
- CZ Objímkový konektor
- DK Stikdåse forbindelse
- FI Pistorasia liitäntä
- GR Υποδοχή σύνδεσης
- NO Tilkobling koblingsboks
- PL Połączenie przez gniazdo



Pag. 25

51

1

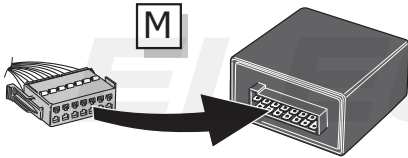

2

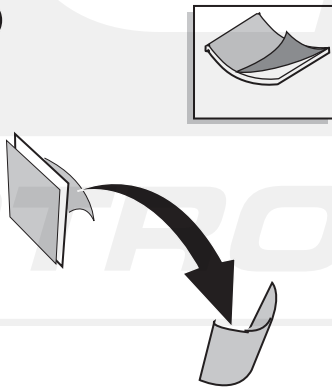

3

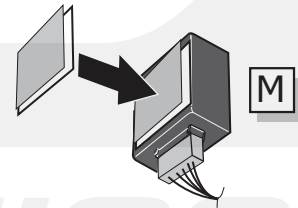

4

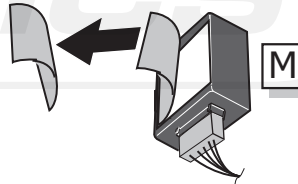

52

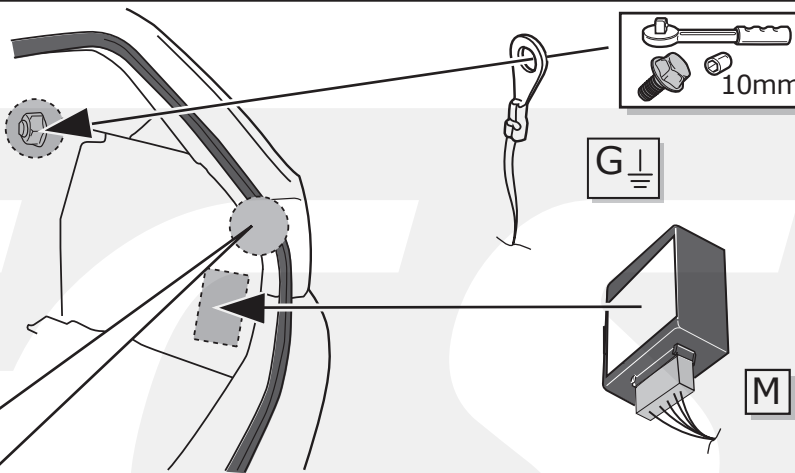
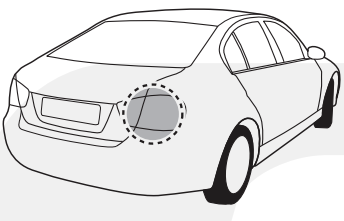

INFO

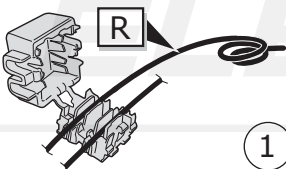

1

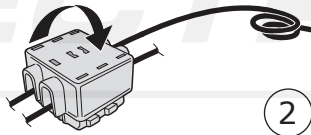

2

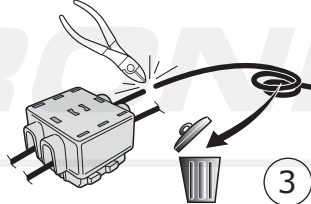

3

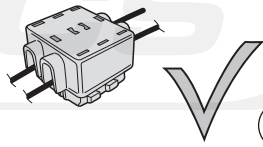

4

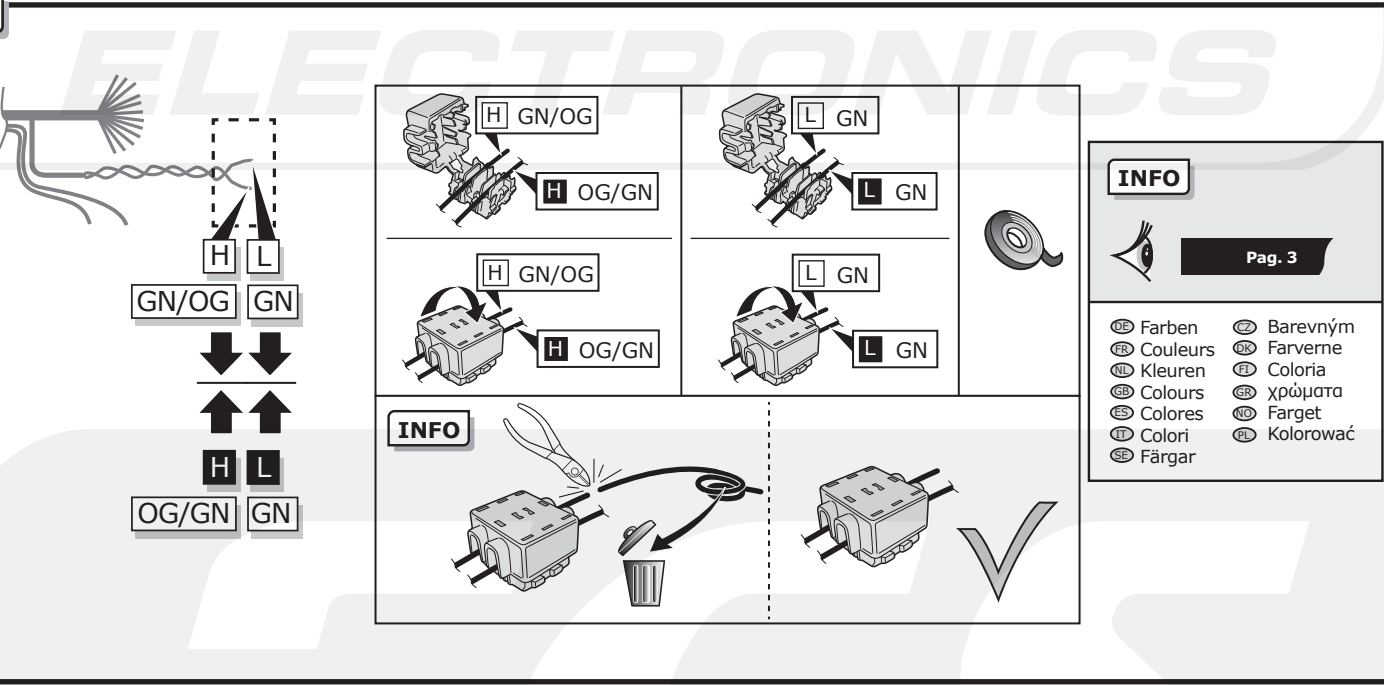
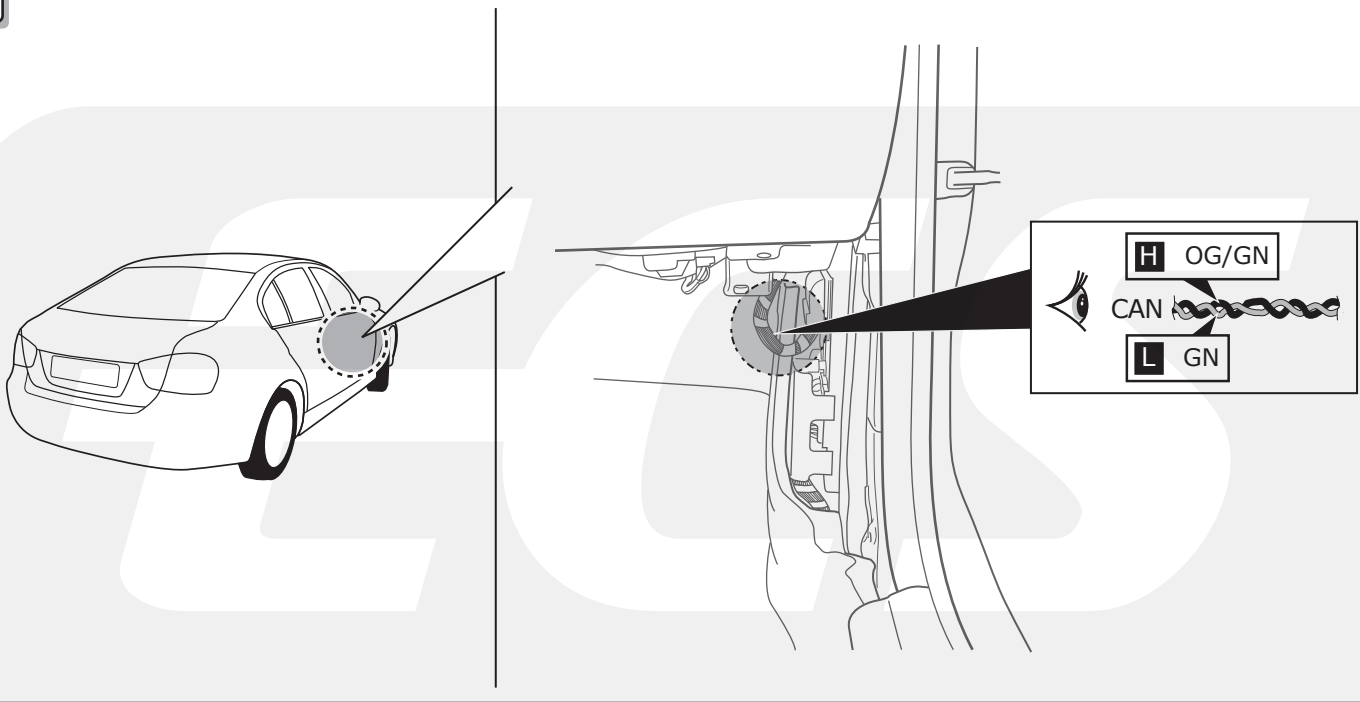

INFO



Pag. 3

- | | |
|---------------|----------------|
| (DE) Farben | (CZ) Barevným |
| (FR) Couleurs | (DK) Farverne |
| (NL) Kleuren | (FI) Coloria |
| (GB) Colours | (GR) χρώματα |
| (ES) Colores | (NO) Farget |
| (IT) Colori | (PL) Kolorować |
| (SE) Färgar | |

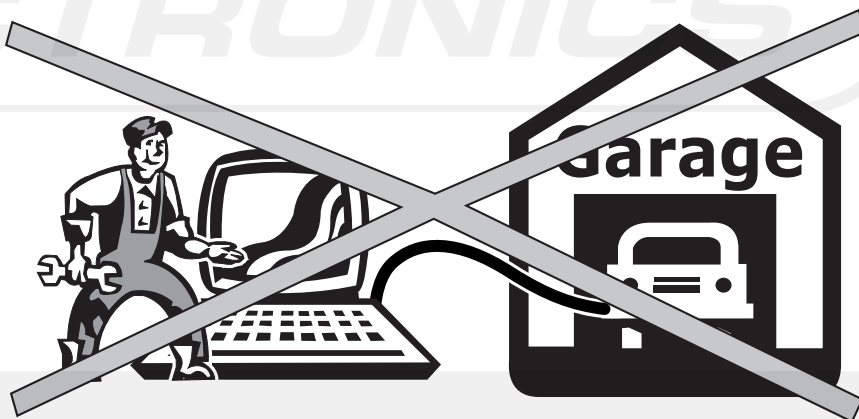
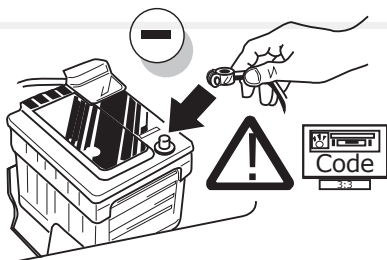
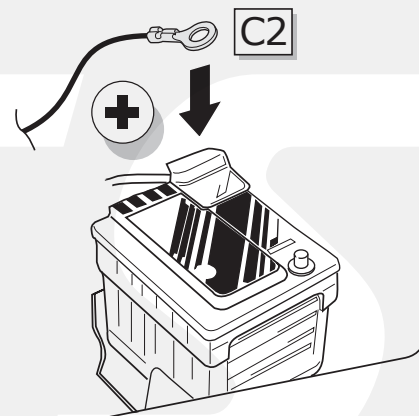
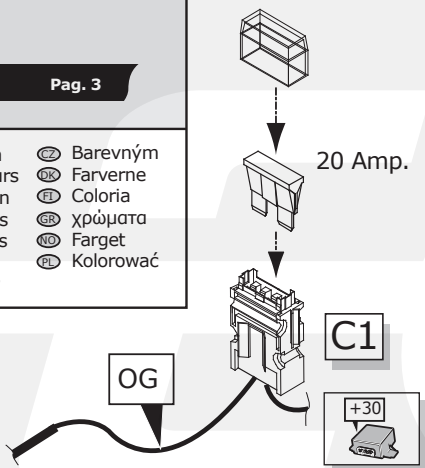

(DE) FUNKTIONEN KONTROLLIEREN MIT EINEM PRÜFGERÄT MIT WIDERSTAND ODER MIT LEUCHTEN MIT DER GENAUEN WATTZAHL!

(FR) CONTRÔLER LES FONCTIONS AVEC UNE BOÎTE DE TEST AVEC DE LA CHARGE OU DES LAMPES AVEC LA QUANTITÉ CORRECTE DE WATT!

(NL) CONTROLEER FUNCTIES MET EEN TESTER MET BELASTING OF LAMPEN MET DE JUISTE WATTAGE!

(GB) TEST ALL CIRCUIT FUNCTIONS WITH A TESTBOX WITH THE CORRECT POWER LOAD FOR EACH UNIT. A TESTBOX ON WHICH ONLY LEDs ARE USED CAN NOT BE USED IN THIS CASE

(ES) ¡CONTROLAR FUNCIONES CON UN TESTER CON CARGA O LUCES CON EL CORRECTO WATTAJE!

(IT) CONTROLLA FUNZIONI CON UN TESTER CON CARICO O LAMPADIE DEL GIUSTO WATT-TAGGIO!

(SE) KONTROLLERA FUNKTIONERNA MED EN TESTARE MED BELASTNING ELLER LAMPOR MED RÄTT WATT-VÄRDE!

(CZ) OVĚŘTE FUNKCE POMOČÍ TESTOVACÍHO BOXU NEBO SVĚTEL S PŘÍSLUŠNÝM VÝKONEM!

(DK) CHECK FUNKTIONERNE MED EN TESTBOKS, MED BELASTNING ELLER MED LYSPÆRER MED DET KORREKTE ANTAL WATT!

(FI) TARKISTA TOIMINNOT KÄYTTÄMÄLLÄ TESTILAITE, JOSSA ON OIKEATEHOINEN KUORMITUS TAI OIKEATEHOISET LAMPUT!

(GR) ΕΛΕΓΤΕ ΤΙΣ ΛΕΙΤΟΥΡΓΙΕΣ ΜΕ ΈΝΑ ΚΙΒΩΤΙΟ ΔΟΚΙΜΗΣ ΜΕ ΦΟΡΤΙΟ Ή ΛΑΜΠΙΤΗΡΕΣ ΣΩΣΤΗΣ ΠΟΣΟΤΗΤΑΣ ΒΑΤ!

(NO) KONTROLER FUNKSJONENE MED EN TESTER MED BELASTNING ELLER LYSPÆRER MED RIKTIG WATTVERDI!

(PL) SPRAWDŹ FUNKCJE UŻYWAJĄC SKRZYŃKI TESTOWEJ Z OBCIĄŻENIEM LUB PODŁĄCZONYMI ŻARÓWKAMI O ODPOWIEDNIEJ MOCY!

INFO

- | | |
|--------------------------------|------------------------------------|
| ⒹⒺ Einzelteile wieder einbauen | ⒸⒶ Znovu zasuňte obložení |
| ⒻⓇ Montez les part enlèves | ⒹⓀ Påsæt beklædningen |
| ⓃⓁ Terug plaatsen onderdelen | ⒻⓂ Asenna verhoilut takaisin |
| ⒼⒷ Reinstall linings | ⒸⓇ Τοποθετήστε ξανά τις επενδύσεις |
| ⒺⓈ Reinstalar componentes | ⓃⓄ Sett tilbake deler |
| ⒾⓉ Rimetti a posto componenti | ⒻⓁ Założyc wykładzinę |
| ⓈⒺ Sätt tillbaka delar | |

60

- | | |
|----|------------------------|
| ⒹⒺ | Gebrauchsanleitung. |
| ⒻⓇ | Mode d'emploi. |
| ⓃⓁ | Gebruikershandleiding. |
| ⒼⒷ | User guide. |
| ⒺⓈ | Guía del usuario. |
| ⒾⓉ | Manuale di istruzioni. |
| ⓈⒺ | Bruksanvisning. |
| ⒸⒶ | Uživatelská příručka. |
| ⒹⓀ | Brugervejledning. |
| ⒻⓂ | Käyttöohjeet. |
| ⒸⓇ | Οδηγός χρήστη. |
| ⓃⓄ | Brukerveiledning. |
| ⒻⓁ | Instrukcja obsługi. |

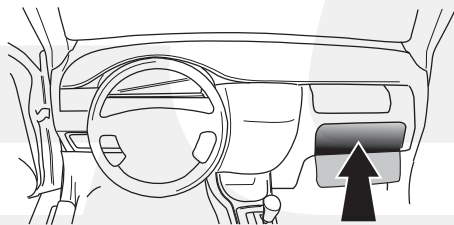

**00800
CALL2ECS
22 55 23 27**

**09.00 - 18.00
Monday - Friday
www.ecs-electronics.nl**

ECS

ELECTRONICS



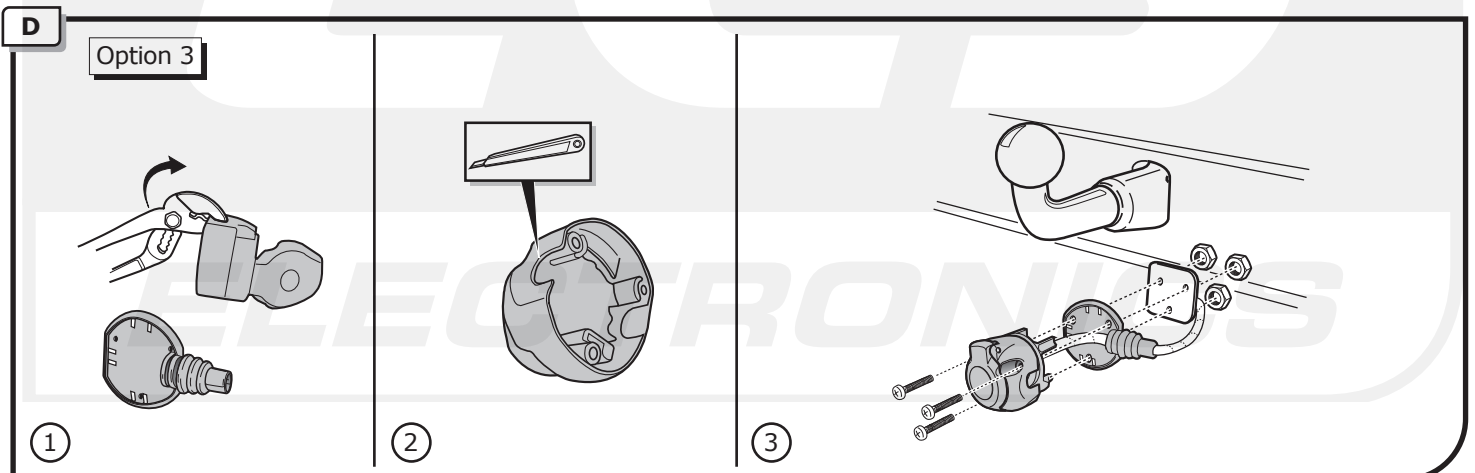
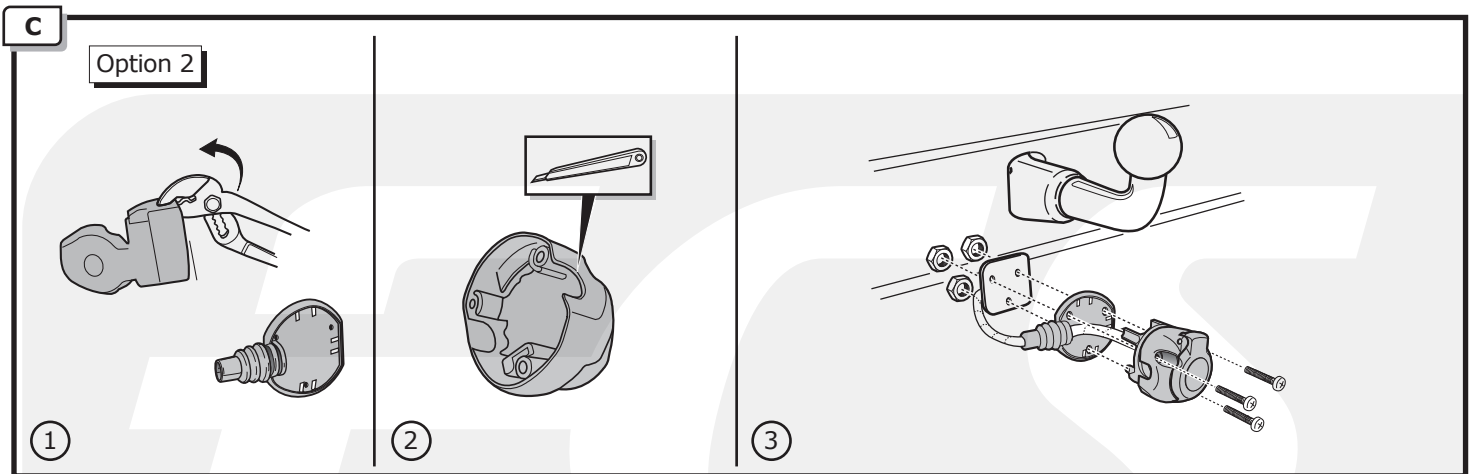
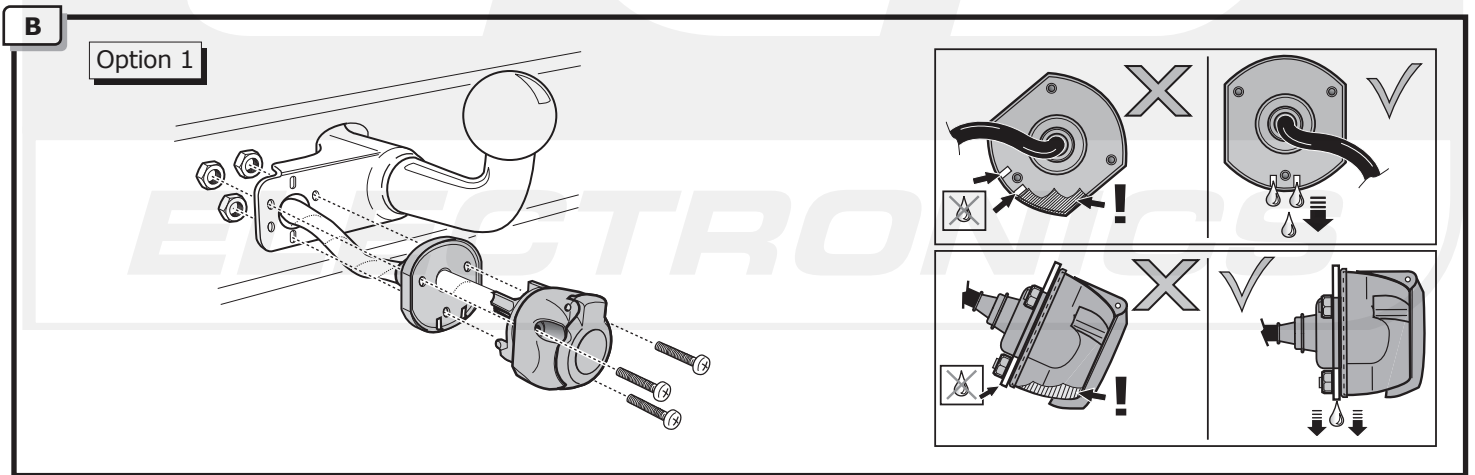
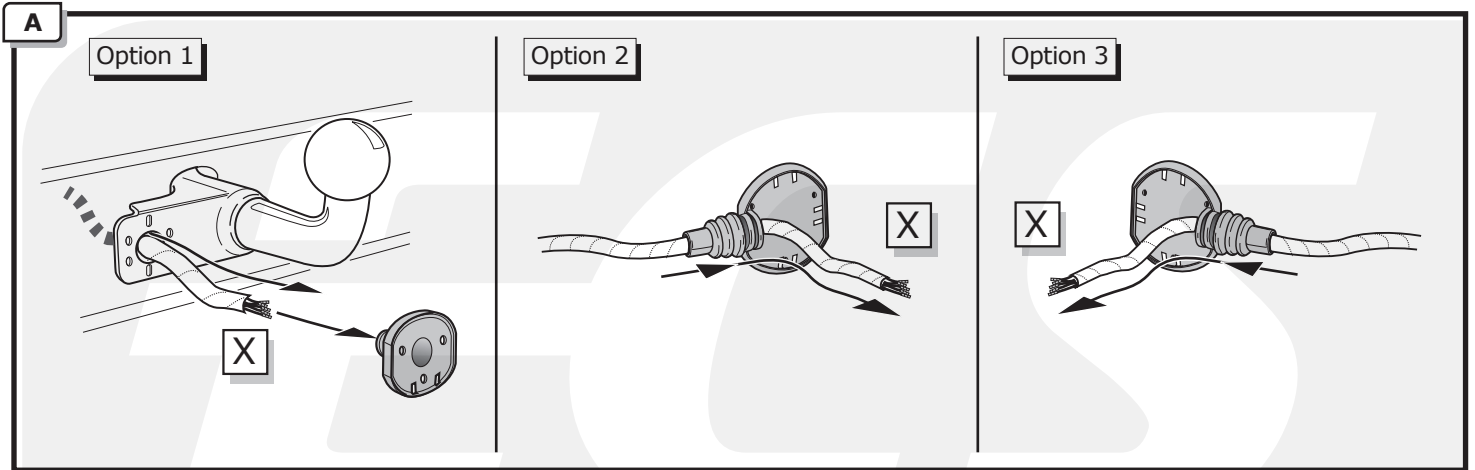





INFO SOCKET CONNECTION

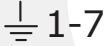

INFO

- (DE) Anschluss Steckdose
- (FR) Connection de la prise
- (NL) Contactdoos aansluiting
- (GB) Socket connection
- (ES) Conexión de la caja de enchufe
- (IT) Allaccio zoccolo
- (SE) Anslutning kontaktdosa



- (CZ) Objímkový konektor
- (DK) Stikdåse forbindelse
- (FI) Pistorasia liitäntä
- (GR) Υποδοχή σύνδεσης
- (NO) Tilkobling koblingsboks
- (PL) Połączenie przez gniazdo

DIN/ISO 1724								
	1/L	2	3/31	4/R	5/58-R	6/54	7/58-L	8
Pmax	21W	21W		21W	42W	3x21W	42W	
(DE)	Gelb	Blau	Weiß	Grün	Braun	Rot	Schwarz	-
(FR)	Jaune	Bleu	Blanc	Vert	Marron	Rouge	Noir	-
(NL)	Geel	Blauw	Wit	Groen	Bruin	Rood	Zwart	-
(GB)	Yellow	Blue	White	Green	Brown	Red	Black	-
(ES)	Amarillo	Azul	Blanco	Verde	Marrón	Rojo	Negro	-
(IT)	Giallo	Blu	Bianco	Verde	Marrone	Rosso	Nero	-
(SE)	Gul	Blå	Vit	Grön	Brun	Röd	Svart	-
(CZ)	Žlutá	Modrá	Bílá	Zelená	Hnědá	Červená	Černá	-
(DK)	Gul	Blå	Hvid	Grøn	Brun	Rød	Sort	-
(FI)	Keltainen	Sininen	Valkoinen	Vihreä	Ruskea	Punainen	Musta	-
(GR)	Κίτρινο	Μπλε	Λευκό	Πράσινο	Καφέ	Κόκκινο	Μαύρο	-
(NO)	Gul	Blå	Hvit	Grønn	Brun	Rød	Svart	-
(PL)	Żółty	Niebieski	Biały	Zielony	Brązowy	Czerwony	Czarny	-

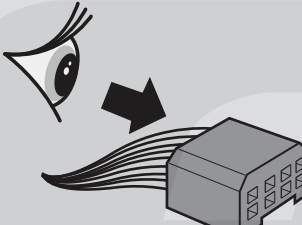
INFO POWER SCHEDULE BW-008-B1



L		54	
R		54G	
58L		BU	
58R		Ground/31	

 **colortable**  **Pag. 3**

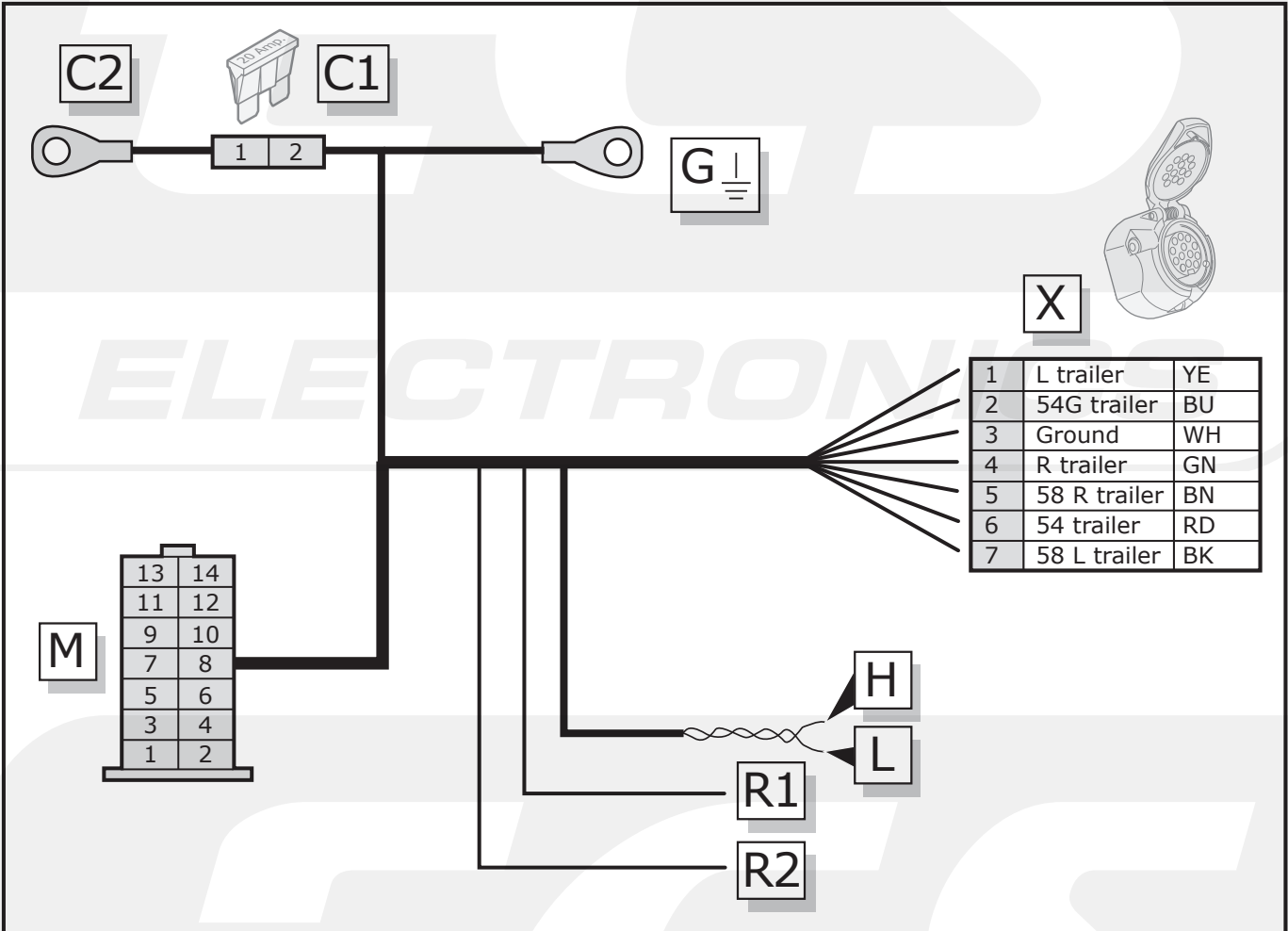

M	1	RD	54 trailer	out
	2	OG	+30 (12 V)	in
	3	RD/WH	R	in
	4	YE	L trailer	out
	5	BURD	54	in
	6	BK	58 L trailer	out
	7	GN	CAN L	in
	8	WH	Ground	-
	9	GN/OG	CAN H	in
	10	GN	R trailer	out
	11	BU	54G trailer	out
	12	BN	58 R trailer	out
	13	-	-	-
	14	OG	+30	in

H	GN/OG	Can H	in
L	GN	Can L	in
R1	BU/RD	54	in
R2	RD/WH	R	in
G	WH	Ground	-

C1	1	RD	+30 (12 V)	in
	2	OG	+30 (12 V)	out